

EVAPCO, INC.



UNIT EVAPORATIVE CONDENSER	MODEL # ATC-DC-1012I-25-1EF	SCALE N.T.S.	DWG. # EGCHTM1202-DRA-ST	REV. -	DATE 6/10/2026	SERIAL #
-------------------------------	--------------------------------	-----------------	-----------------------------	-----------	-------------------	----------

- NOTES:
- (M)- FAN MOTOR LOCATION
 - HEAVIEST SECTION IS COIL SECTION
 - MPT DENOTES MALE PIPE THREAD
FPT DENOTES FEMALE PIPE THREAD
BFW DENOTES BEVELED FOR WELDING
 - +UNIT WEIGHT DOES NOT INCLUDE ACCESSORIES (SEE ACCESSORY DRAWINGS)
 - MAKE-UP WATER PRESSURE
20 psi MIN [137 kPa], 50 psi MAX [344 kPa]

- DIMENSIONS LISTED AS FOLLOWS:
ENGLISH IN
[METRIC] [mm]
- * - APPROXIMATE DIMENSIONS DO NOT USE FOR PRE-FABRICATION OF CONNECTING PIPING.

**FACE 2
PLAN VIEW**



FACE 1



FACE 2

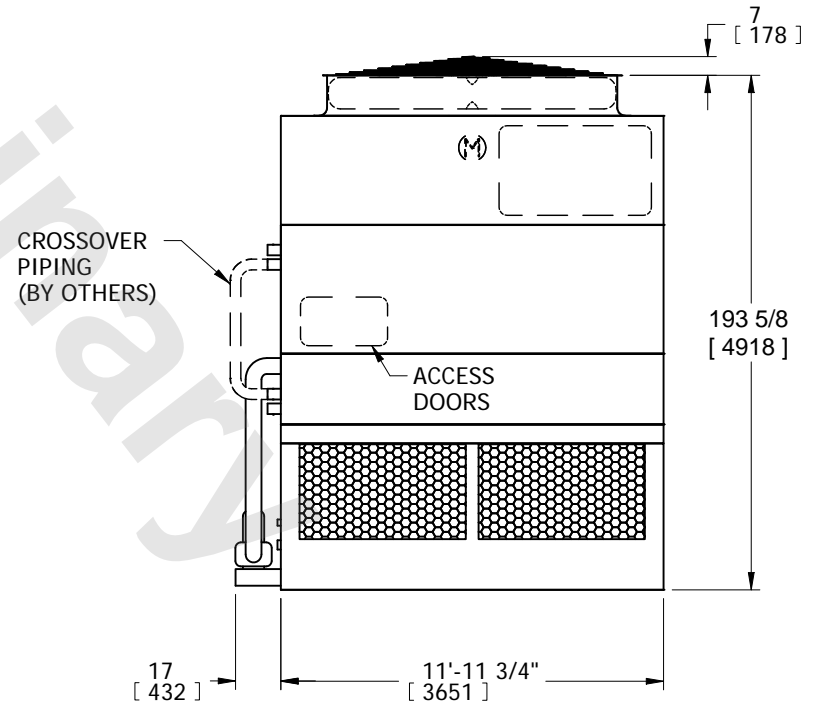

FACE 1

SHIPPING WEIGHT 14700 lbs+ [6670] kg+	OPERATING WEIGHT 19920 lbs+ [9040] kg+	HEAVIEST SECTION WEIGHT 9710 lbs+ [4405] kg+	NO. OF SHIPPING SECTIONS 3	DRAWN BY: SFR
--	---	---	-------------------------------	------------------