

| | | |
|---------|-----------|-----------|
| UNIT | CONDENSER | |
| MODEL # | ATC-702E | SCALE NTS |

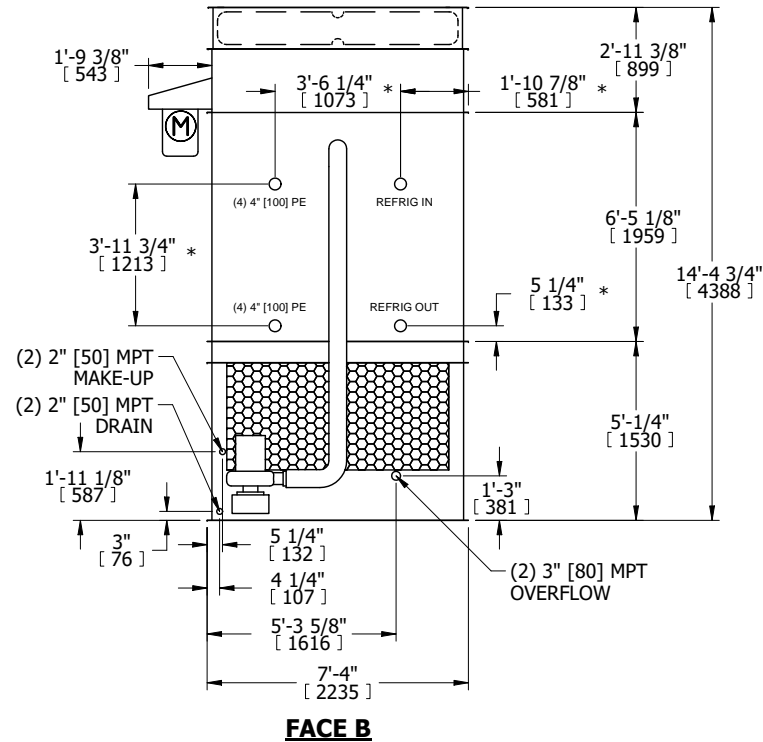

| | | | |
|----------|-------------------|------|-----------|
| DWG. # | CW4C072414-DRA-ST | REV. | - |
| SERIAL # | | DATE | 5/17/2026 |

- NOTES:
- (M)- FAN MOTOR LOCATION
 - HEAVIEST SECTION IS FAN/CASING SECTION
 - MPT DENOTES MALE PIPE THREAD
FPT DENOTES FEMALE PIPE THREAD
BFW DENOTES BEVELED FOR WELDING
GVD DENOTES GROOVED
FLG DENOTES FLANGE
PE DENOTES PLAIN END
 - +UNIT WEIGHT DOES NOT INCLUDE ACCESSORIES (SEE ACCESSORY DRAWINGS)
 - MAKE-UP WATER PRESSURE
20 psi MIN [137 kPa], 50 psi MAX [344 kPa]
 - *-APPROXIMATE DIMENSIONS DO NOT USE FOR PRE-FABRICATION OF CONNECTING PIPING
 - 3/4" [19mm] DIA. MOUNTING HOLES. REFER TO RECOMMENDED STEEL SUPPORT DRAWING.
 - DIMENSIONS LISTED AS FOLLOWS:
ENGLISH FT-IN
METRIC [mm]

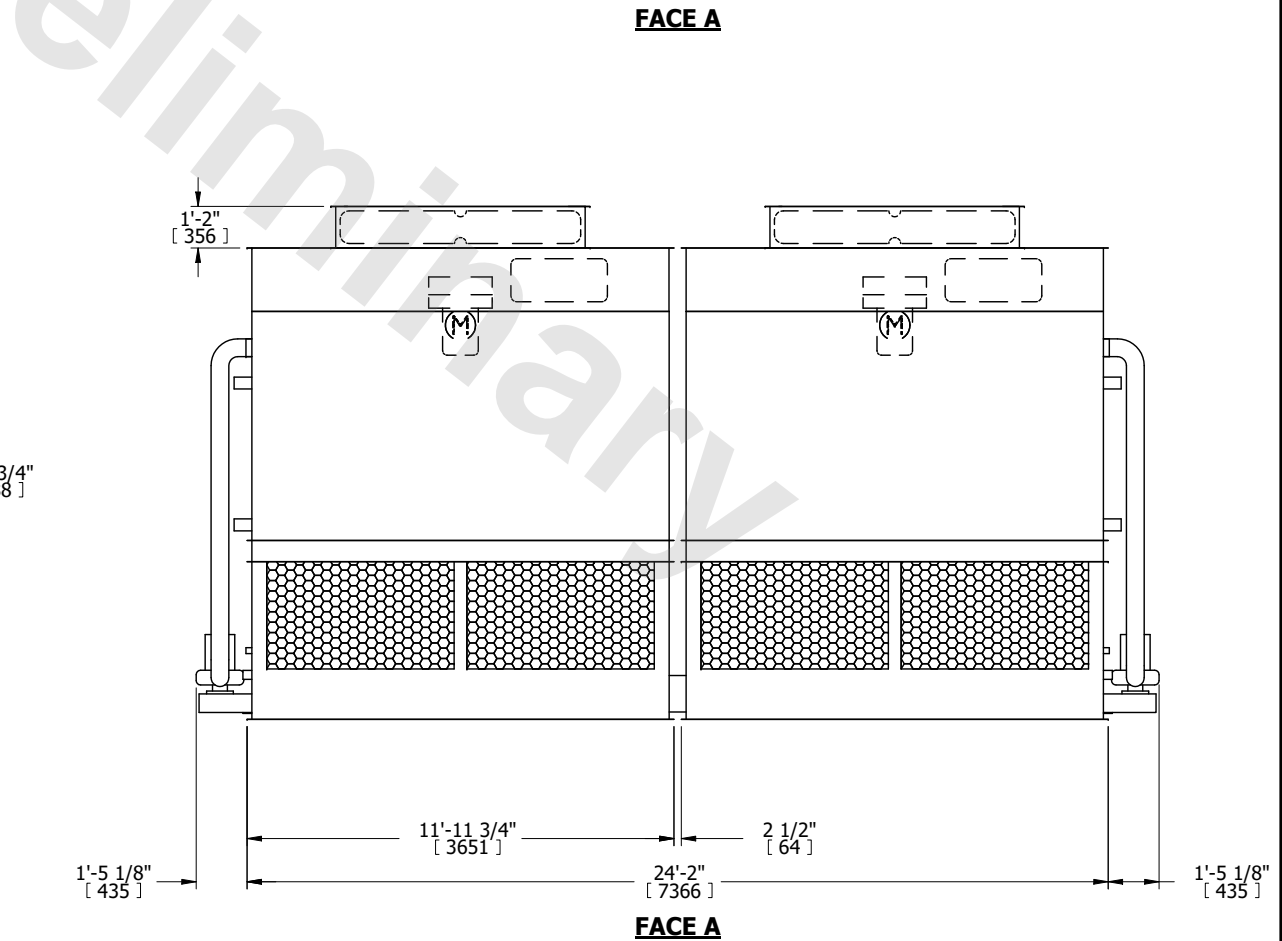
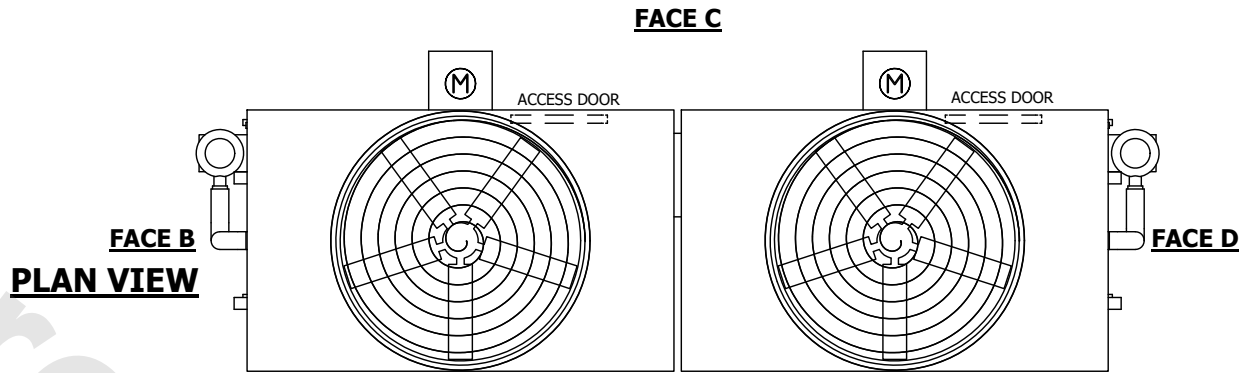

| | | | | | | | | | |
|-----------------|------------------------|------------------|------------------------|-------------------------|-----------------------|--------------------------|---|-----------|-----|
| SHIPPING WEIGHT | 39300 lbs+ [17830] kg+ | OPERATING WEIGHT | 42370 lbs+ [19220] kg+ | HEAVIEST SECTION WEIGHT | 16020 lbs+ [7270] kg+ | NO. OF SHIPPING SECTIONS | 4 | DRAWN BY: | TAM |
|-----------------|------------------------|------------------|------------------------|-------------------------|-----------------------|--------------------------|---|-----------|-----|