

UNIT	CONDENSER	
MODEL #	ATC-296E	SCALE NTS

EVAPCO, INC.

DWG. #	CW4C071408-DRA-ST	REV	-
SERIAL #		DATE:	7/5/2026

NOTES

- (M)- FAN MOTOR LOCATION
- HEAVIEST SECTION IS FAN/CASING SECTION
- MPT DENOTES MALE PIPE THREAD
FPT DENOTES FEMALE PIPE THREAD
BFW DENOTES BEVELED FOR WELDING
GVD DENOTES GROOVED
FLG DENOTES FLANGE
PE DENOTES PLAIN END
- +UNIT WEIGHT DOES NOT INCLUDE ACCESSORIES (SEE ACCESSORY DRAWINGS)
- MAKE-UP WATER PRESSURE
20 psi MIN [137 kPa], 50 psi MAX [344 kPa]
- *-APPROXIMATE DIMENSIONS DO NOT USE FOR PRE-FABRICATION OF CONNECTING PIPING
- 3/4" [19mm] DIA. MOUNTING HOLES. REFER TO RECOMMENDED STEEL SUPPORT DRAWING.
- DIMENSIONS LISTED AS FOLLOWS:
ENGLISH FT-IN
METRIC [mm]

**FACE B
PLAN VIEW**

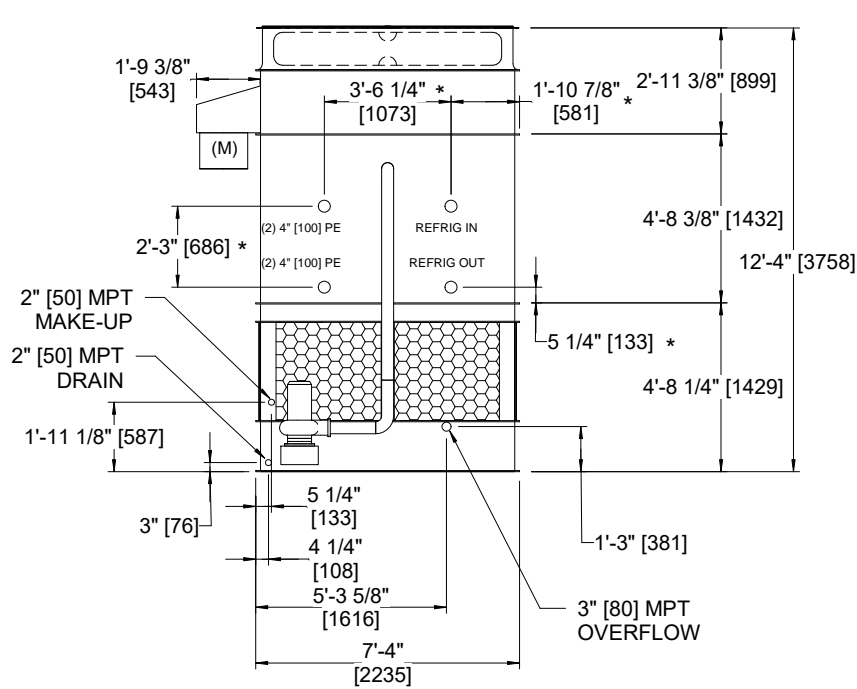

FACE B

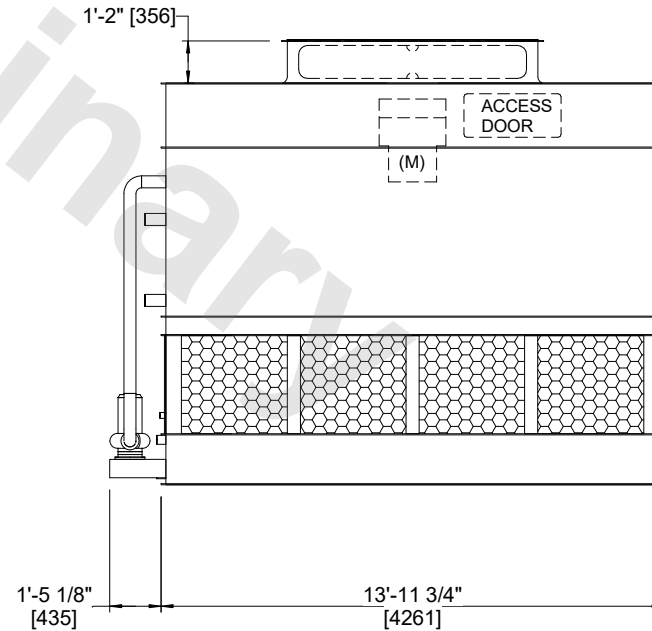

FACE A

SHIPPING WEIGHT	12180 lbs+ [5525] kg+	OPERATING WEIGHT	14640 lbs+ [6645] kg+	HEAVIEST SECTION WEIGHT	9990 lbs+ [4535] kg+	NO. OF SHIPPING SECTIONS	2	DRAWN BY:	JLG
-----------------	-----------------------	------------------	-----------------------	-------------------------	----------------------	--------------------------	---	-----------	-----