

UNIT	COOLING TOWER	
MODEL #	AT 217-319	SCALE NTS

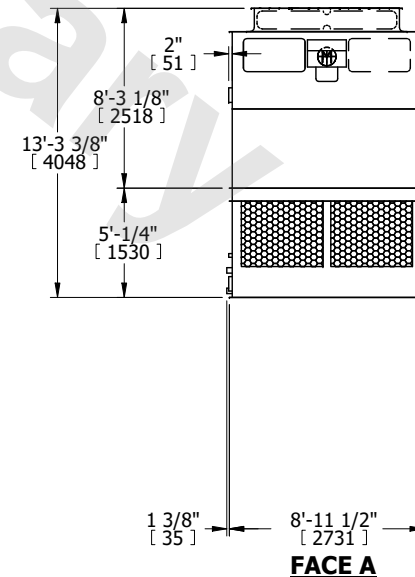

DWG. #	T3170936-DRG-ST	REV.	-
SERIAL #		DATE	4/18/2026

- NOTES:
- (M)- FAN MOTOR LOCATION
  - HEAVIEST SECTION IS UPPER SECTION
  - MPT DENOTES MALE PIPE THREAD  
FPT DENOTES FEMALE PIPE THREAD  
BFW DENOTES BEVELED FOR WELDING  
GVD DENOTES GROOVED  
FLG DENOTES FLANGE
  - +UNIT WEIGHT DOES NOT INCLUDE ACCESSORIES (SEE ACCESSORY DRAWINGS)
  - MAKE-UP WATER PRESSURE  
20 psi MIN [137 kPa], 50 psi MAX [344 kPa]
  - 3/4" [19MM] DIA. MOUNTING HOLES.  
REFER TO RECOMMENDED STEEL SUPPORT DRAWING
  - DIMENSIONS LISTED AS FOLLOWS:  
ENGLISH FT-IN  
[METRIC] [mm]

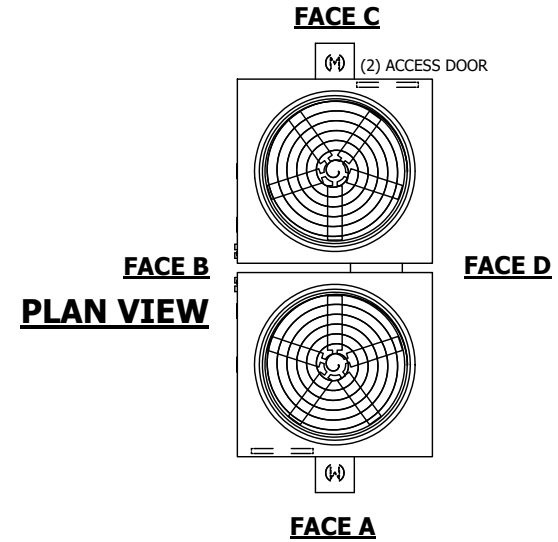

SHIPPING WEIGHT	9100 lbs+ [4130] kg+	OPERATING WEIGHT	14780 lbs+ [6705] kg+	HEAVIEST SECTION WEIGHT	3010 lbs+ [1370] kg+	NO. OF SHIPPING SECTIONS	4	DRAWN BY:	KDS
-----------------	----------------------	------------------	-----------------------	-------------------------	----------------------	--------------------------	---	-----------	-----