

| | | |
|---------|---------------|-----------|
| UNIT | COOLING TOWER | |
| MODEL # | AT 424-4P40 | SCALE NTS |



| | | | |
|----------|-----------------|------|-----------|
| DWG. # | T3244048-DRC-ST | REV. | - |
| SERIAL # | | DATE | 4/21/2026 |

- NOTES:
- (M)- FAN MOTOR LOCATION
 - HEAVIEST SECTION IS UPPER SECTION
 - MPT DENOTES MALE PIPE THREAD
FPT DENOTES FEMALE PIPE THREAD
BFW DENOTES BEVELED FOR WELDING
GVD DENOTES GROOVED
FLG DENOTES FLANGE
 - +UNIT WEIGHT DOES NOT INCLUDE ACCESSORIES (SEE ACCESSORY DRAWINGS)
 - MAKE-UP WATER PRESSURE
20 psi MIN [137 kPa], 50 psi MAX [344 kPa]
 - 3/4" [19MM] DIA. MOUNTING HOLES. REFER TO RECOMENDED STEEL SUPPORT DRAWING.
 - DIMENSIONS LISTED AS FOLLOWS:
ENGLISH FT-IN
[METRIC] [mm]

FACE B
PLAN VIEW

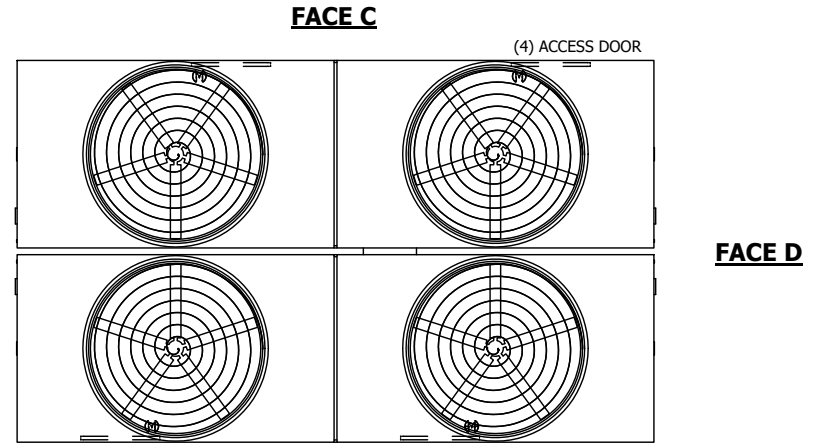

FACE A

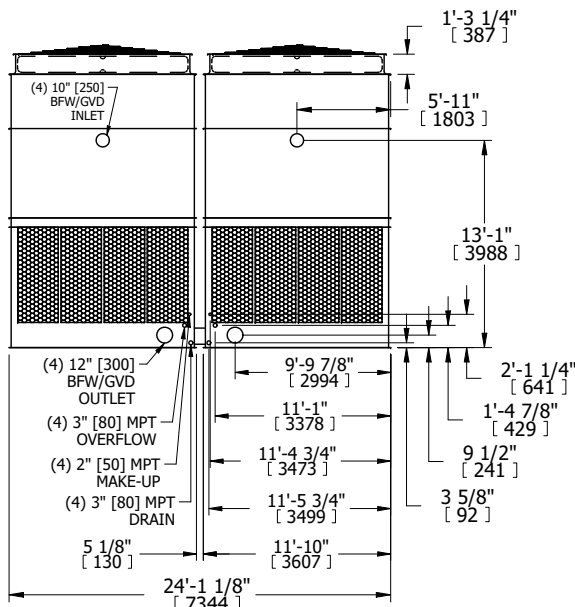

FACE B

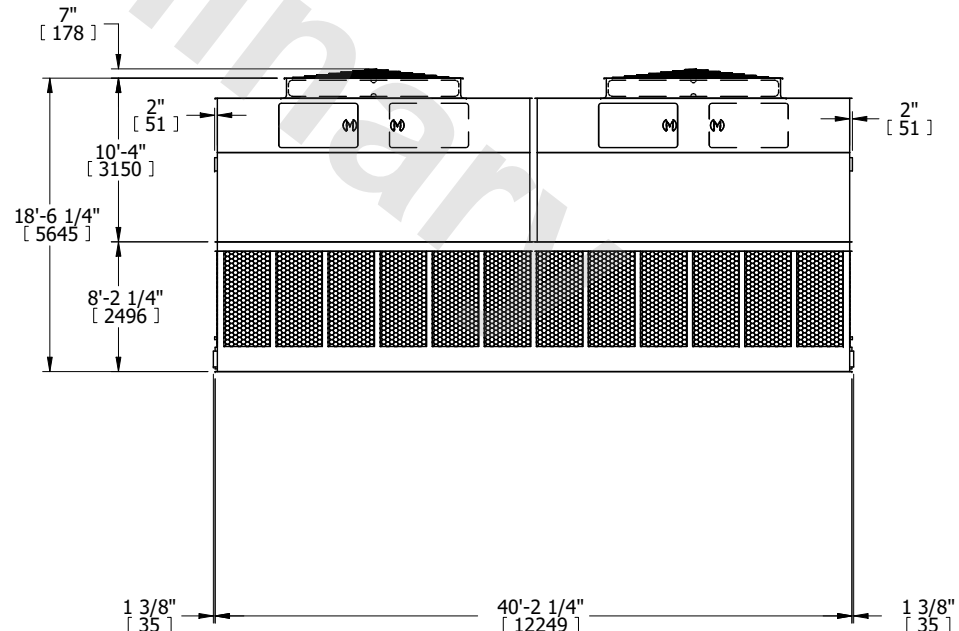

FACE A

| | | | | | | | | | |
|-----------------|------------------------|------------------|------------------------|-------------------------|----------------------|--------------------------|---|-----------|-----|
| SHIPPING WEIGHT | 55720 lbs+ [25275] kg+ | OPERATING WEIGHT | 96920 lbs+ [43965] kg+ | HEAVIEST SECTION WEIGHT | 9430 lbs+ [4280] kg+ | NO. OF SHIPPING SECTIONS | 6 | DRAWN BY: | BLL |
|-----------------|------------------------|------------------|------------------------|-------------------------|----------------------|--------------------------|---|-----------|-----|