

UNIT	CLOSED CIRCUIT COOLER	
MODEL #	ATWB 9-6L12-Z	SCALE NTS

EVAPCO, INC.



DWG. #	WB3091212-DRC-SF	REV.	-
SERIAL #		DATE	4/15/2026

- NOTES:
- (M) - FAN MOTOR LOCATION
 - HEAVIEST SECTION IS UPPER SECTION
 - MPT DENOTES MALE PIPE THREAD
FPT DENOTES FEMALE PIPE THREAD
BFW DENOTES BEVELED FOR WELDING
GVD DENOTES GROOVED
FLG DENOTES FLANGE
PE DENOTES PLAIN END
 - + UNIT WEIGHT DOES NOT INCLUDE ACCESSORIES (SEE SEPARATE DRAWINGS FOR ACCESSORIES)
 - MAKE-UP WATER PRESSURE
20 psi MIN [137 kPa], 50 psi MAX [344 kPa]
 - * - APPROXIMATE DIMENSIONS DO NOT USE FOR PRE-FABRICATION OF CONNECTING PIPING
 - SERIES FLOW PIPING AND AUX. CROSSOVER DRAIN BY OTHERS
 - 3/4" [19MM] DIA. MOUNTING HOLES. REFER TO RECOMMENDED STEEL SUPPORT DRAWING.
 - DIMENSIONS LISTED AS FOLLOWS:
ENGLISH FT-IN
METRIC [mm]

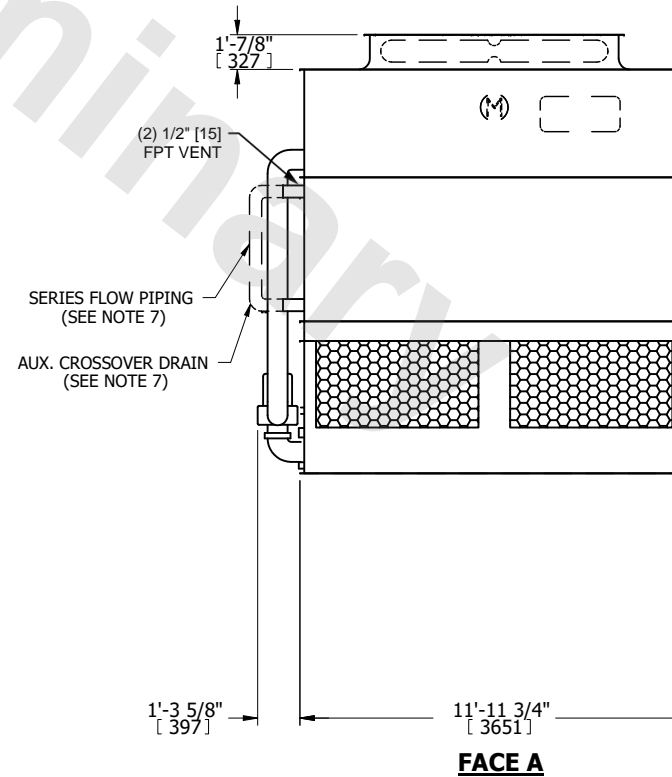
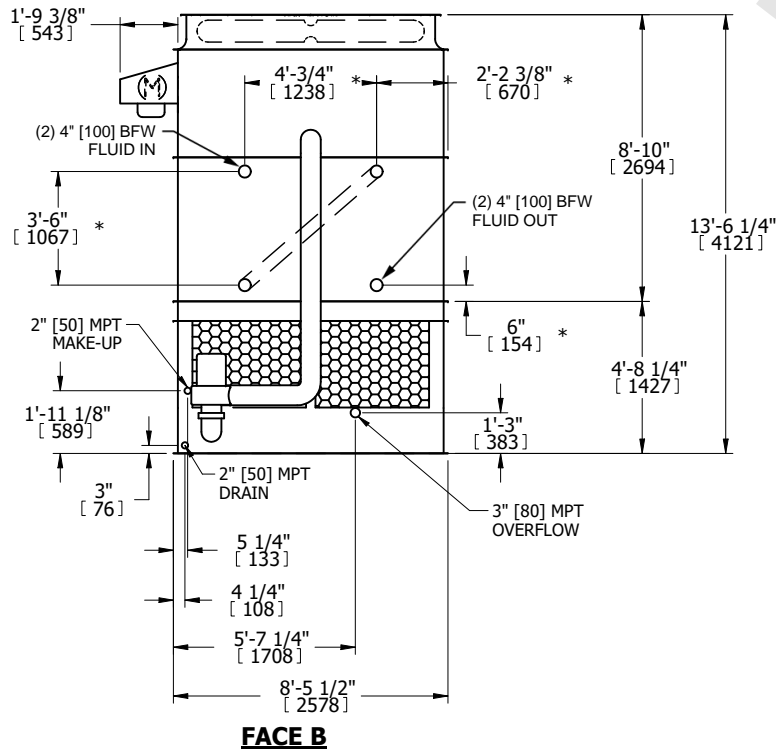
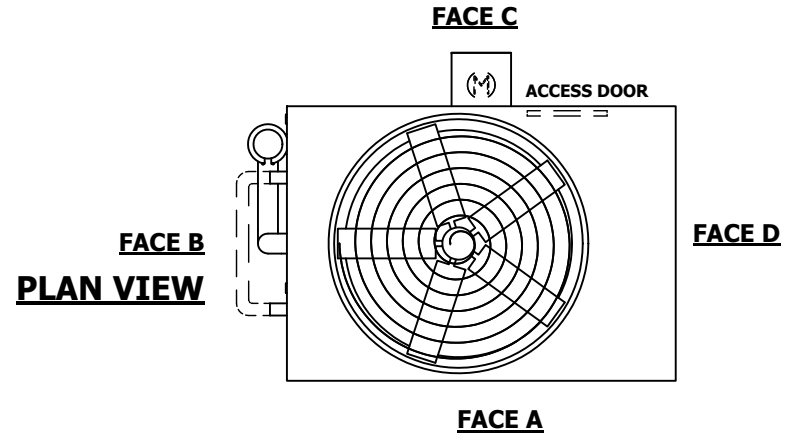

SHIPPING WEIGHT	14960 lbs+ [6790] kg+	OPERATING WEIGHT	22080 lbs+ [10020] kg+	HEAVIEST SECTION WEIGHT	13160 lbs+ [5970] kg+	NO. OF SHIPPING SECTIONS	2	DRAWN BY:	JLG
-----------------	-----------------------	------------------	------------------------	-------------------------	-----------------------	--------------------------	---	-----------	-----