

|         |                       |           |
|---------|-----------------------|-----------|
| UNIT    | CLOSED CIRCUIT COOLER |           |
| MODEL # | ATWB 17-4M14-Z        | SCALE NTS |

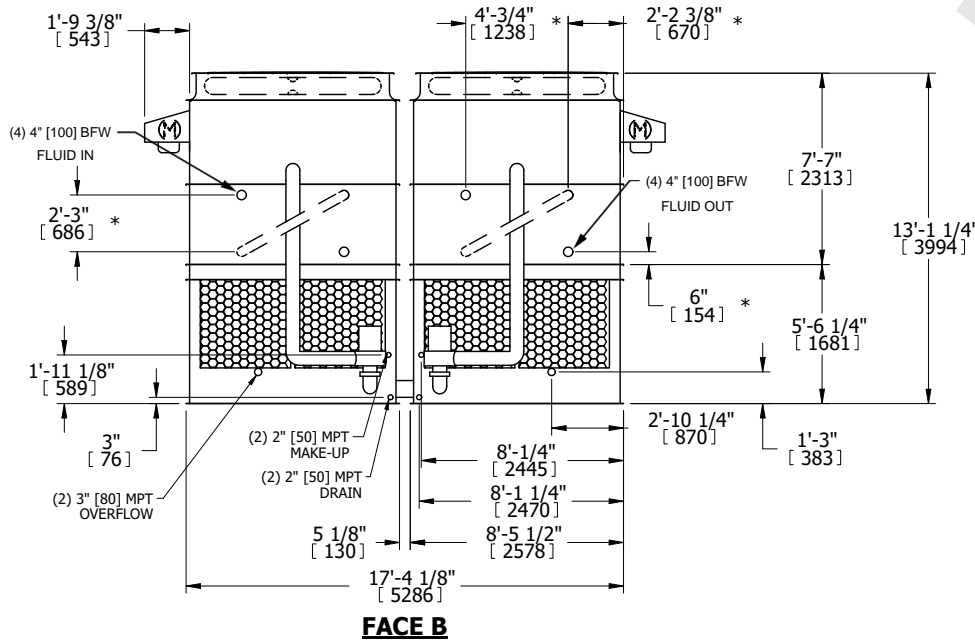

|          |                  |      |           |
|----------|------------------|------|-----------|
| DWG. #   | WB3171408-DRD-SF | REV. | -         |
| SERIAL # |                  | DATE | 6/28/2026 |

- NOTES:
- (M)- FAN MOTOR LOCATION
  - HEAVIEST SECTION IS UPPER SECTION
  - MPT DENOTES MALE PIPE THREAD  
FPT DENOTES FEMALE PIPE THREAD  
BFW DENOTES BEVELED FOR WELDING  
GVD DENOTES GROOVED  
FLG DENOTES FLANGE  
PE DENOTES PLAIN END
  - +UNIT WEIGHT DOES NOT INCLUDE ACCESSORIES (SEE ACCESSORY DRAWINGS)
  - MAKE-UP WATER PRESSURE  
20 psi MIN [137 kPa], 50 psi MAX [344 kPa]
  - \*-APPROXIMATE DIMENSIONS DO NOT USE FOR PRE-FABRICATION OF CONNECTING PIPING
  - SERIES FLOW PIPING AND AUX. CROSSOVER DRAIN BY OTHERS.
  - 3/4" [19MM] DIA. MOUNTING HOLES. REFER TO RECOMMENDED STEEL SUPPORT DRAWING.
  - DIMENSIONS LISTED AS FOLLOWS:  
ENGLISH FT-IN  
METRIC [mm]

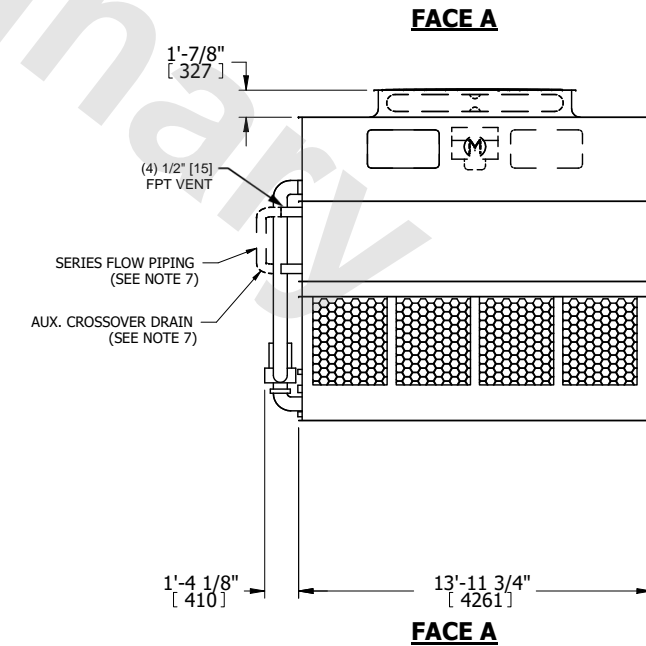
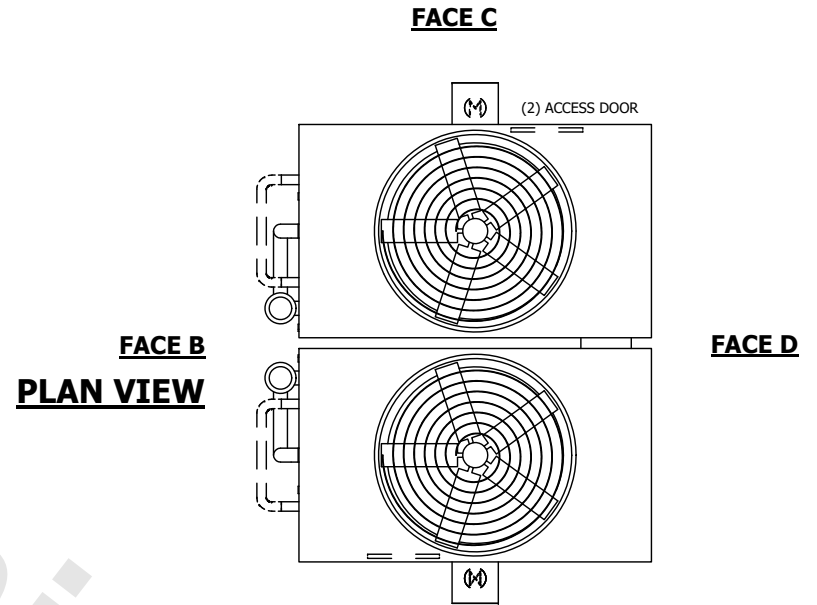

|                 |                        |                  |                        |                         |                       |                          |   |           |     |
|-----------------|------------------------|------------------|------------------------|-------------------------|-----------------------|--------------------------|---|-----------|-----|
| SHIPPING WEIGHT | 26660 lbs+ [12095] kg+ | OPERATING WEIGHT | 40600 lbs+ [18420] kg+ | HEAVIEST SECTION WEIGHT | 11320 lbs+ [5135] kg+ | NO. OF SHIPPING SECTIONS | 4 | DRAWN BY: | JLG |
|-----------------|------------------------|------------------|------------------------|-------------------------|-----------------------|--------------------------|---|-----------|-----|