

UNIT	CLOSED CIRCUIT COOLER	
MODEL #	ATWB 7-519	SCALE NTS

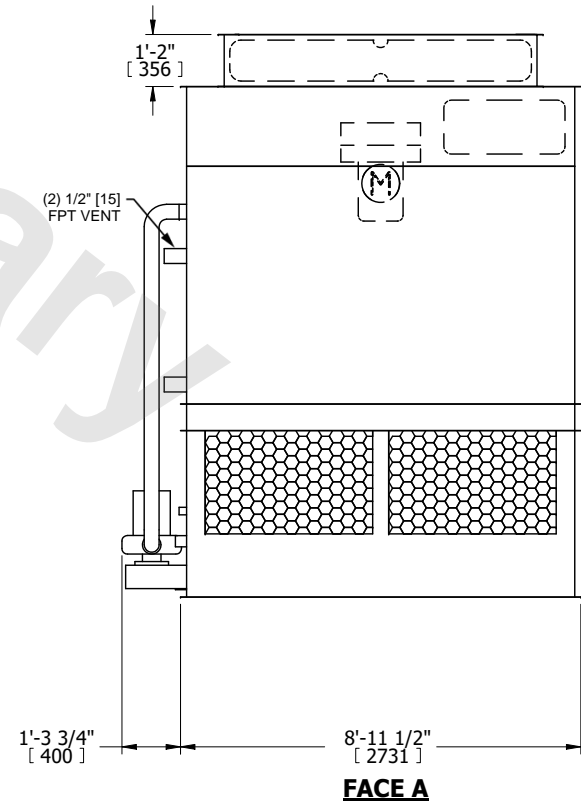

DWG. #	CW4C070910-DRA-ST	REV.	-
SERIAL #		DATE	4/22/2026

- NOTES:
- (M)- FAN MOTOR LOCATION
 - HEAVIEST SECTION IS FAN/CASING SECTION
 - MPT DENOTES MALE PIPE THREAD
FPT DENOTES FEMALE PIPE THREAD
BFW DENOTES BEVELED FOR WELDING
GVD DENOTES GROOVED
FLG DENOTES FLANGE
PE DENOTES PLAIN END
 - +UNIT WEIGHT DOES NOT INCLUDE ACCESSORIES (SEE ACCESSORY DRAWINGS)
 - MAKE-UP WATER PRESSURE
20 psi MIN [137 kPa], 50 psi MAX [344 kPa]
 - *-APPROXIMATE DIMENSIONS DO NOT USE FOR PRE-FABRICATION OF CONNECTING PIPING
 - 3/4" [19mm] DIA. MOUNTING HOLES. REFER TO RECOMMENDED STEEL SUPPORT DRAWING.
 - DIMENSIONS LISTED AS FOLLOWS:
ENGLISH FT-IN
METRIC [mm]

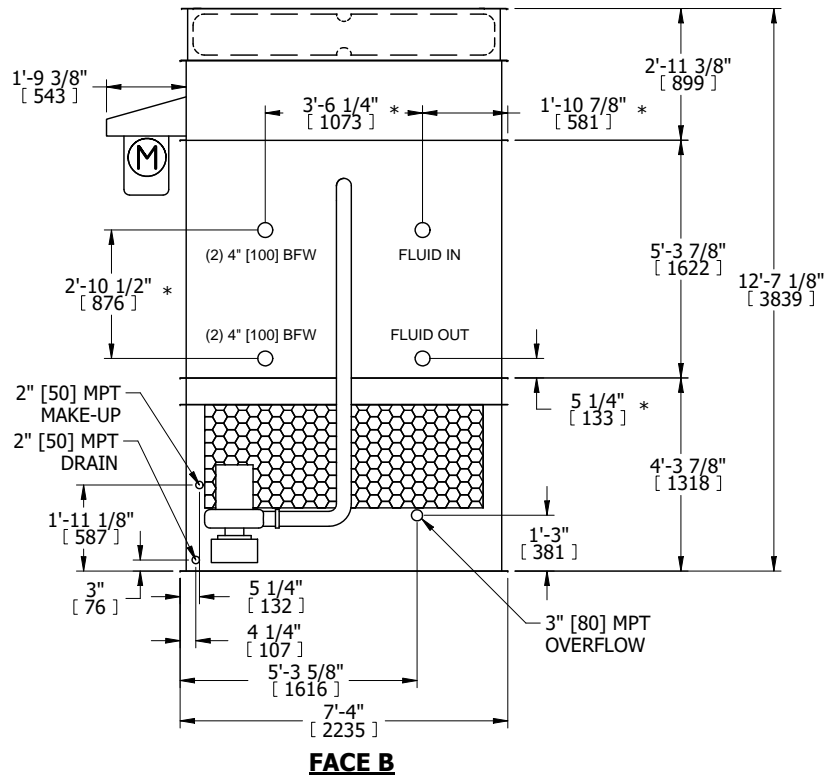
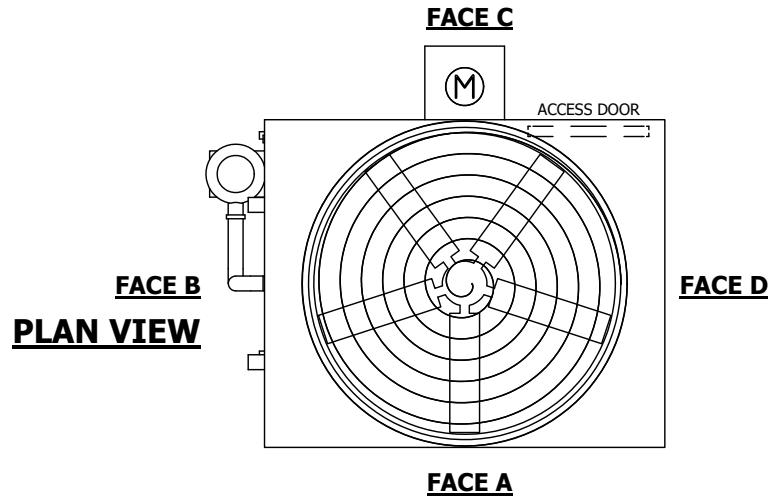

SHIPPING WEIGHT	9700 lbs+ [4400] kg+	OPERATING WEIGHT	12960 lbs+ [5880] kg+	HEAVIEST SECTION WEIGHT	8110 lbs+ [3680] kg+	NO. OF SHIPPING SECTIONS	2	DRAWN BY:	TAM
-----------------	----------------------	------------------	-----------------------	-------------------------	----------------------	--------------------------	---	-----------	-----