

UNIT	CLOSED CIRCUIT COOLER	
MODEL #	LRWB 3-3H6	SCALE NTS

EVAPCO, INC.

DWG. #	WV030606-DRC-ST	REV.	-
SERIAL #		DATE	5/9/2026

- NOTES:
- (M)- FAN MOTOR LOCATION
 - MPT DENOTES MALE PIPE THREAD
FPT DENOTES FEMALE PIPE THREAD
BFW DENOTES BEVELED FOR WELDING
GVD DENOTES GROOVED
FLG DENOTES FLANGE
PE DENOTES PLAIN END
 - +UNIT WEIGHT DOES NOT INCLUDE ACCESSORIES (SEE ACCESSORY DRAWINGS)
 - 3/4" [19mm] DIA. MOUNTING HOLES. REFER TO RECOMMENDED STEEL SUPPORT DRAWING
 - DIMENSIONS LISTED AS FOLLOWS: ENGLISH FT IN [METRIC] [mm]
 - * - APPROXIMATE DIMENSIONS DO NOT USE FOR PRE-FABRICATION OF CONNECTING PIPING
 - MAKE-UP WATER PRESSURE
20 psi [137 kPa] MIN, 50 psi [344 kPa] MAX

FACE B
PLAN VIEW

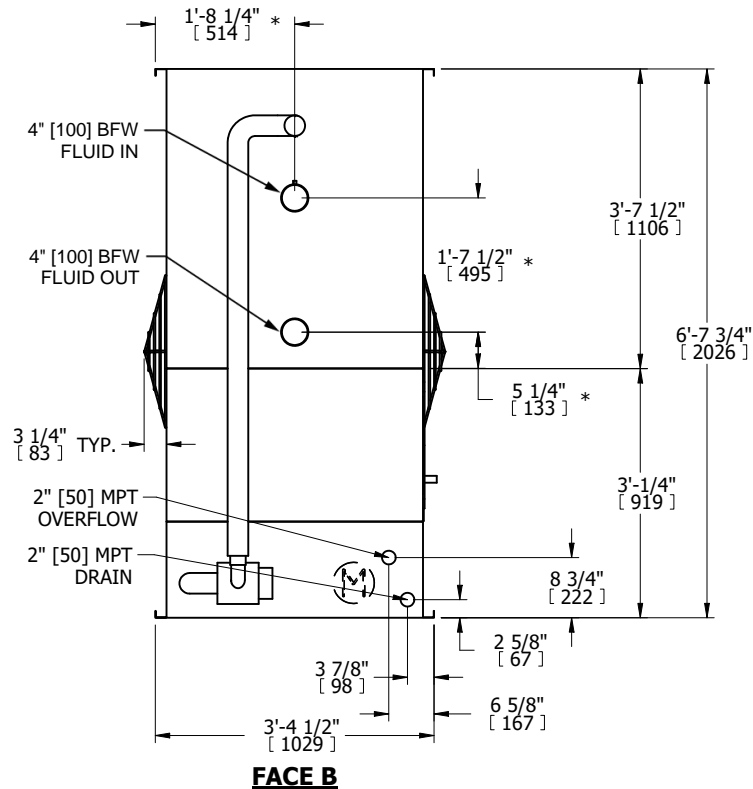

FACE C

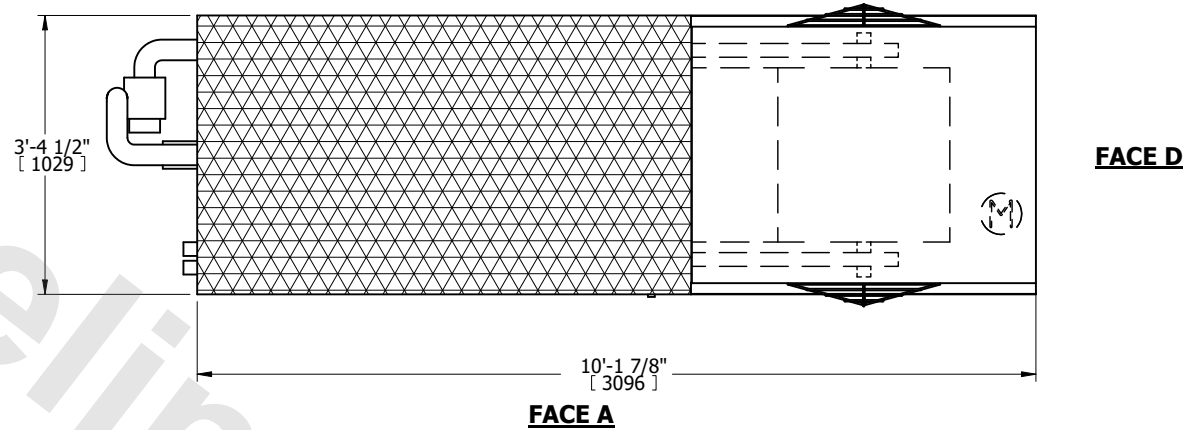

FACE A

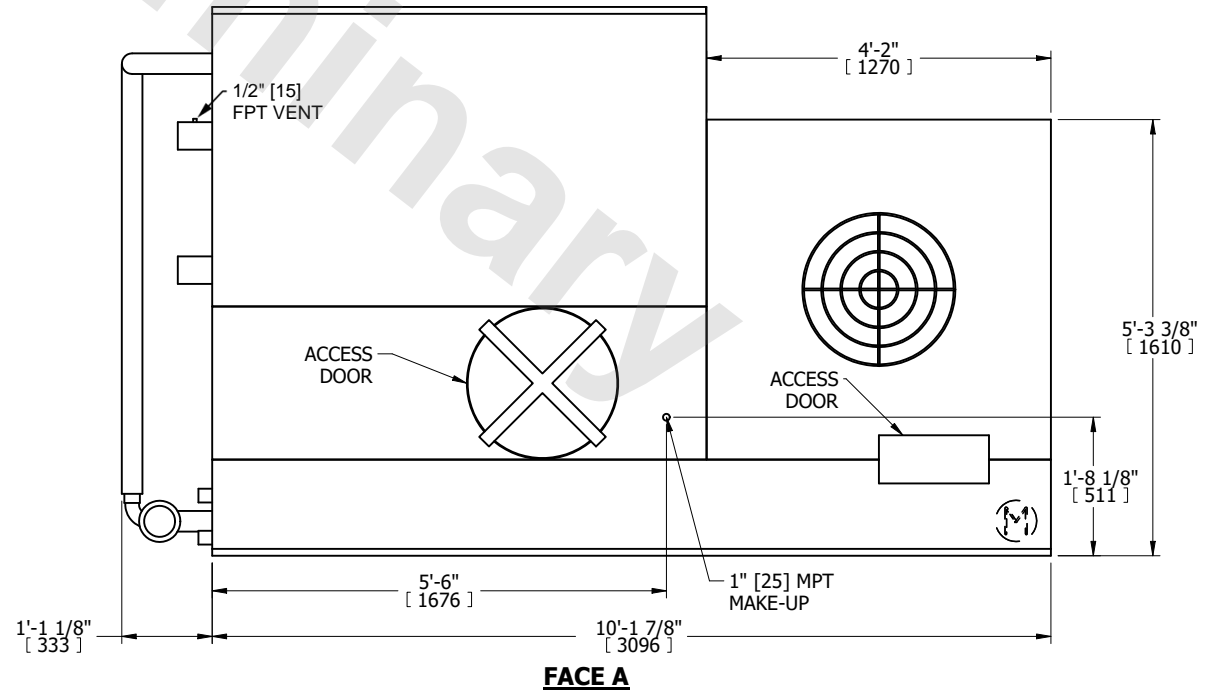

FACE A

SHIPPING WEIGHT	2550 lbs+ [1160] kg+	OPERATING WEIGHT	3880 lbs+ [1760] kg+	HEAVIEST SECTION WEIGHT	2550 lbs+ [1160] kg+	NO. OF SHIPPING SECTIONS	1	DRAWN BY:	TLS
-----------------	----------------------	------------------	----------------------	-------------------------	----------------------	--------------------------	---	-----------	-----