

UNIT	CLOSED CIRCUIT COOLER	
MODEL #	LSWE 4-5J9-Z	SCALE NTS

EVAPCO, INC.

DWG. #	WLE040910-DRD-SF	REV.	-
SERIAL #		DATE	4/5/2026

NOTES:

- (M)- FAN MOTOR LOCATION
- MPT DENOTES MALE PIPE THREAD
FPT DENOTES FEMALE PIPE THREAD
BFW DENOTES BEVELED FOR WELDING
GVD DENOTES GROOVED
FLG DENOTES FLANGE
PE DENOTES PLAIN END
- +UNIT WEIGHT DOES NOT INCLUDE ACCESSORIES (SEE ACCESSORY DRAWINGS)
- 3/4" [19mm] DIA. MOUNTING HOLES. REFER TO RECOMMENDED STEEL SUPPORT DRAWING
- DIMENSIONS LISTED AS FOLLOWS: ENGLISH FT IN [METRIC] [mm]
- * - APPROXIMATE DIMENSIONS DO NOT USE FOR PRE-FABRICATION OF CONNECTING PIPING
- HEAVIEST SECTION IS COIL SECTION
- MAKE-UP WATER PRESSURE
20 psi [137 kPa] MIN, 50 psi [344 kPa] MAX
- MAKE-UP CONNECTION LOCATED 7-5/8" [194] FROM CONNECTION END OF UNIT
- SERIES FLOW PIPING AND AUX. CROSSOVER DRAIN ARE BY OTHERS

**FACE B
PLAN VIEW**

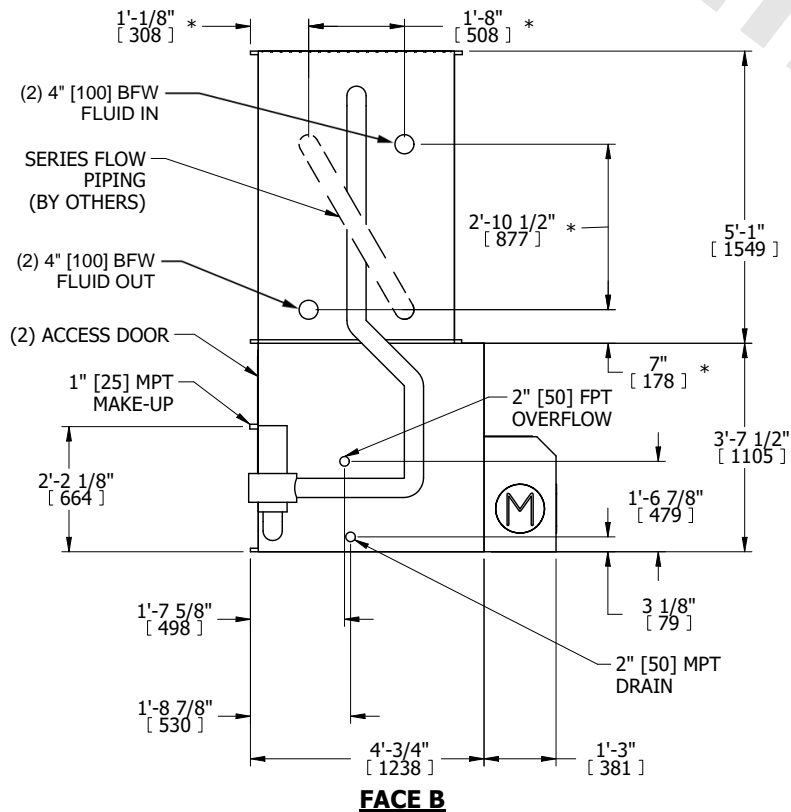
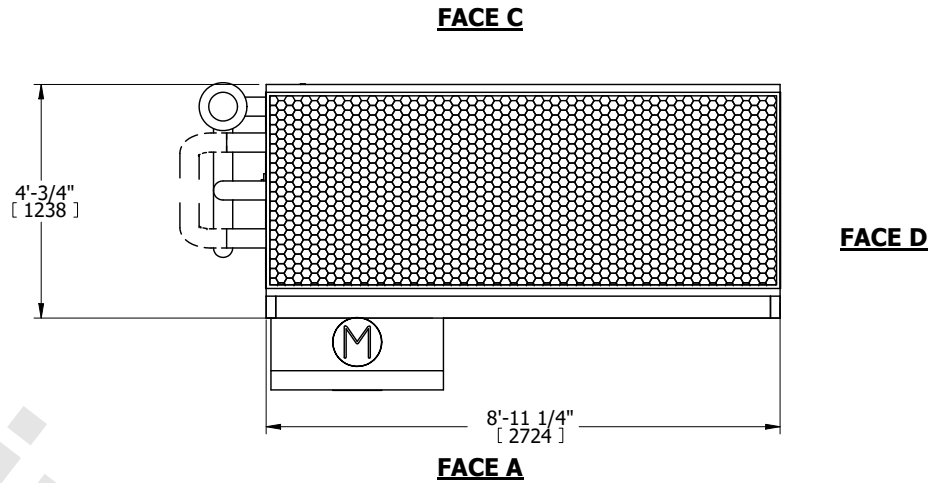

FACE B

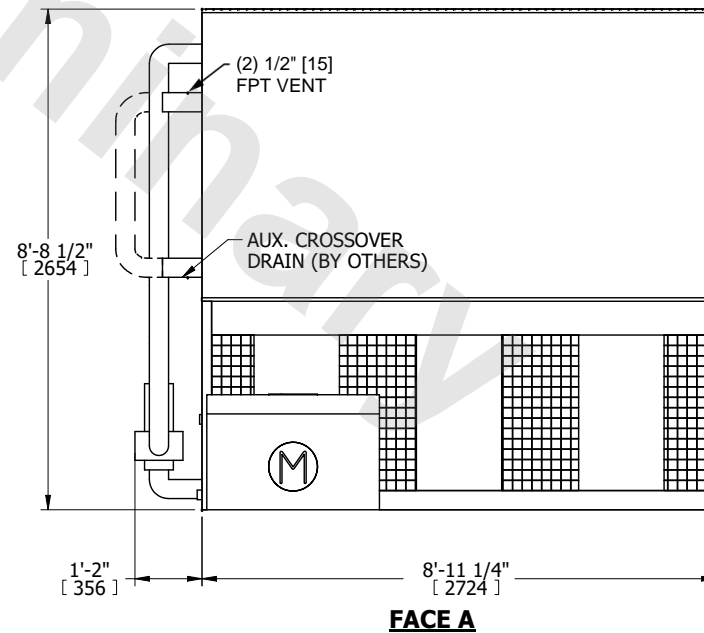

FACE A

SHIPPING WEIGHT	4980 lbs+ [2260] kg+	OPERATING WEIGHT	6910 lbs+ [3135] kg+	HEAVIEST SECTION WEIGHT	3300 lbs+ [1500] kg+	NO. OF SHIPPING SECTIONS	2	DRAWN BY:	TLS
-----------------	----------------------	------------------	----------------------	-------------------------	----------------------	--------------------------	---	-----------	-----