

UNIT	CLOSED CIRCUIT COOLER	
MODEL #	LSWE 10-3L18-Z	SCALE NTS



DWG. #	WLETM1806-DRD-SF	REV.	-
SERIAL #		DATE	4/4/2026

- NOTES:
- (M)- FAN MOTOR LOCATION
 - MPT DENOTES MALE PIPE THREAD
FPT DENOTES FEMALE PIPE THREAD
BFW DENOTES BEVELED FOR WELDING
GVD DENOTES GROOVED
FLG DENOTES FLANGE
PE DENOTES PLAIN END
 - +UNIT DOES NOT INCLUDE ACCESSORIES (SEE ACCESSORY DRAWINGS)
 - 3/4" [19mm] DIA. MOUNTING HOLES. REFER TO RECOMMENDED STEEL SUPPORT DRAWING
 - DIMENSIONS LISTED AS FOLLOWS: ENGLISH FT IN [METRIC] [mm]
 - * - APPROXIMATE DIMENSIONS DO NOT USE FOR PRE-FABRICATION OF CONNECTING PIPING
 - HEAVIEST SECTION IS COIL SECTION
 - MAKE-UP WATER PRESSURE
20 psi [137 kPa] MIN, 50 psi [344 kPa] MAX
 - SERIES FLOW PIPING AND AUX. CROSSOVER DRAIN ARE BY OTHERS

FACE B
PLAN VIEW



FACE C



FACE D

FACE A

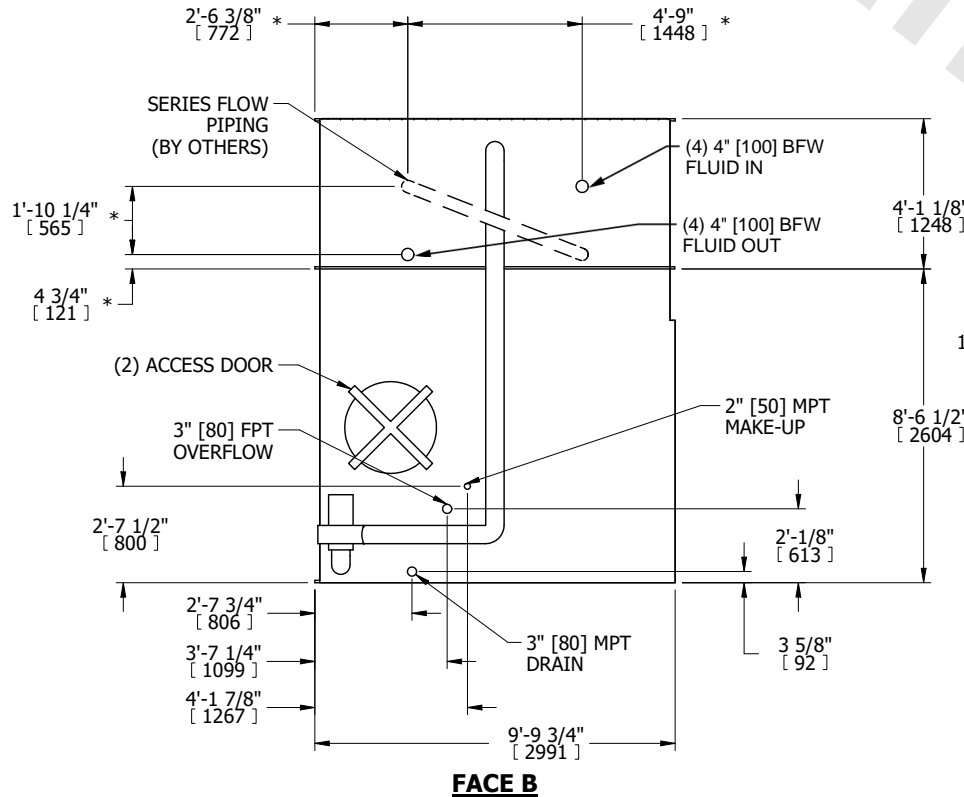

FACE B

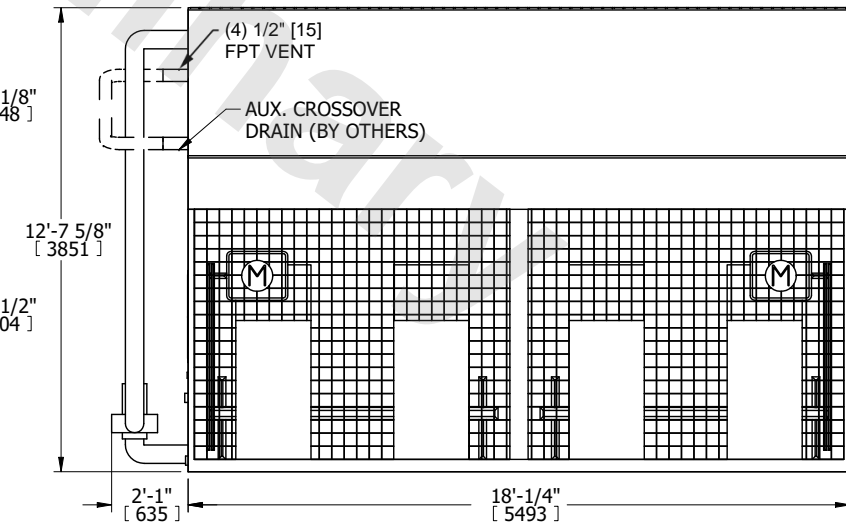

FACE A

SHIPPING WEIGHT	18720 lbs+ [8495] kg+	OPERATING WEIGHT	28470 lbs+ [12915] kg+	HEAVIEST SECTION WEIGHT	11530 lbs+ [5230] kg+	NO. OF SHIPPING SECTIONS	2	DRAWN BY:	TL5
-----------------	-----------------------	------------------	------------------------	-------------------------	-----------------------	--------------------------	---	-----------	-----