

|         |                       |           |
|---------|-----------------------|-----------|
| UNIT    | CLOSED CIRCUIT COOLER |           |
| MODEL # | eco-ATWB 9-3112-Z     | SCALE NTS |



|          |                  |      |           |
|----------|------------------|------|-----------|
| DWG. #   | WB3091206-DRC-SF | REV. | -         |
| SERIAL # |                  | DATE | 5/17/2026 |

NOTES:

- (M) - FAN MOTOR LOCATION
- HEAVIEST SECTION IS UPPER SECTION
- MPT DENOTES MALE PIPE THREAD  
FPT DENOTES FEMALE PIPE THREAD  
BFW DENOTES BEVELED FOR WELDING  
GVD DENOTES GROOVED  
FLG DENOTES FLANGE  
PE DENOTES PLAIN END
- + UNIT WEIGHT DOES NOT INCLUDE ACCESSORIES (SEE SEPARATE DRAWINGS FOR ACCESSORIES)
- MAKE-UP WATER PRESSURE  
20 psi MIN [137 kPa], 50 psi MAX [344 kPa]
- \* - APPROXIMATE DIMENSIONS DO NOT USE FOR PRE-FABRICATION OF CONNECTING PIPING
- SERIES FLOW PIPING AND AUX. CROSSOVER DRAIN BY OTHERS
- 3/4" [19MM] DIA. MOUNTING HOLES. REFER TO RECOMMENDED STEEL SUPPORT DRAWING.
- DIMENSIONS LISTED AS FOLLOWS:  
ENGLISH FT-IN  
METRIC [mm]

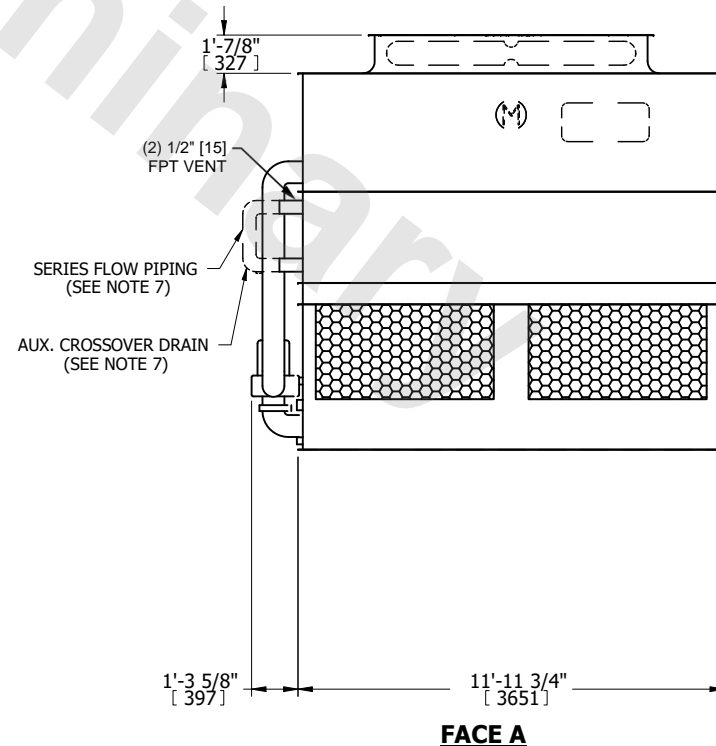
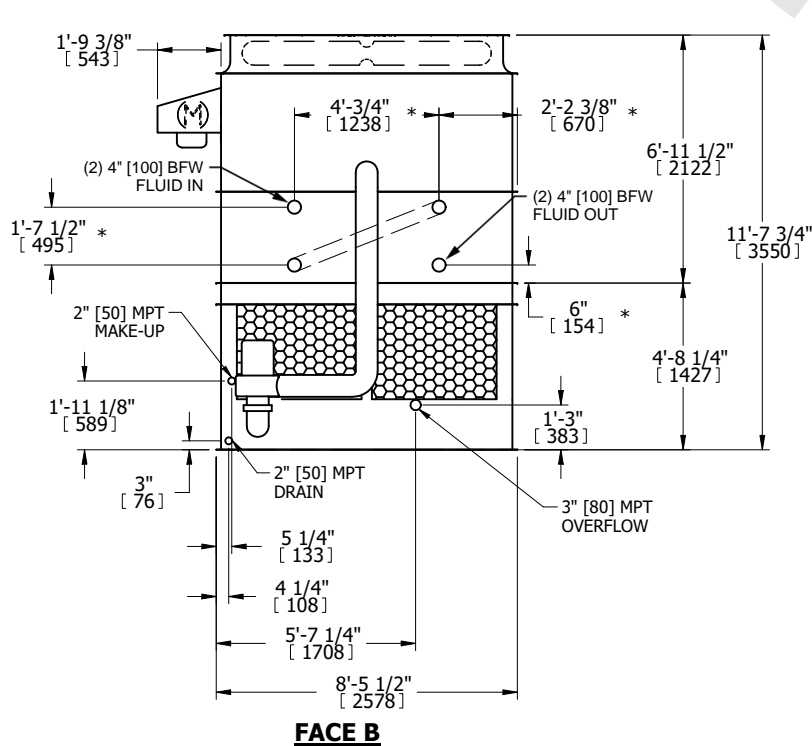
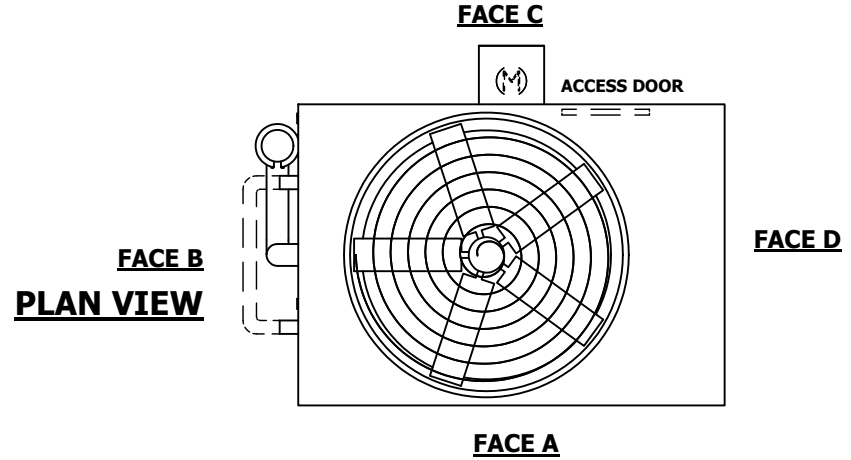

|                 |                       |                  |                       |                         |                       |                          |   |           |     |
|-----------------|-----------------------|------------------|-----------------------|-------------------------|-----------------------|--------------------------|---|-----------|-----|
| SHIPPING WEIGHT | 11900 lbs+ [5400] kg+ | OPERATING WEIGHT | 17330 lbs+ [7865] kg+ | HEAVIEST SECTION WEIGHT | 10030 lbs+ [4550] kg+ | NO. OF SHIPPING SECTIONS | 2 | DRAWN BY: | JLG |
|-----------------|-----------------------|------------------|-----------------------|-------------------------|-----------------------|--------------------------|---|-----------|-----|