

EVAPCO, INC.



UNIT	CLOSED CIRCUIT COOLER	MODEL #	eco-ATWB 24-4N18-Z	SCALE	N.T.S.	DWG. #	EG241808-DRA-SF	REV.	-	DATE	5/21/2026	SERIAL #	
------	-----------------------	---------	--------------------	-------	--------	--------	-----------------	------	---	------	-----------	----------	--

- NOTES:
- (M)- FAN MOTOR LOCATION
 - HEAVIEST SECTION IS UPPER SECTION
 - MPT DENOTES MALE PIPE THREAD
FPT DENOTES FEMALE PIPE THREAD
BFW DENOTES BEVELED FOR WELDING
 - +UNIT WEIGHT DOES NOT INCLUDE ACCESSORIES (SEE ACCESSORY DRAWINGS)
 - MAKE-UP WATER PRESSURE
20 psi MIN [137 kPa], 50 psi MAX [344 kPa]
 - * -APPROXIMATE DIMENSIONS DO NOT USE FOR PRE-FABRICATION OF CONNECTING PIPING
 - VENT PROVIDED ON CLOSED CIRCUIT COOLERS ONLY
 - SERIES FLOW PIPING AND AUX. CROSSOVER DRAIN BY OTHERS

**FACE 2
PLAN VIEW**



FACE 1

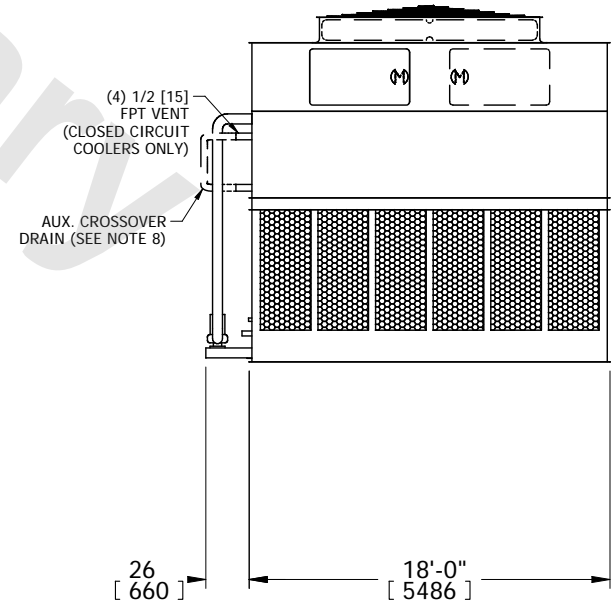

FACE 2

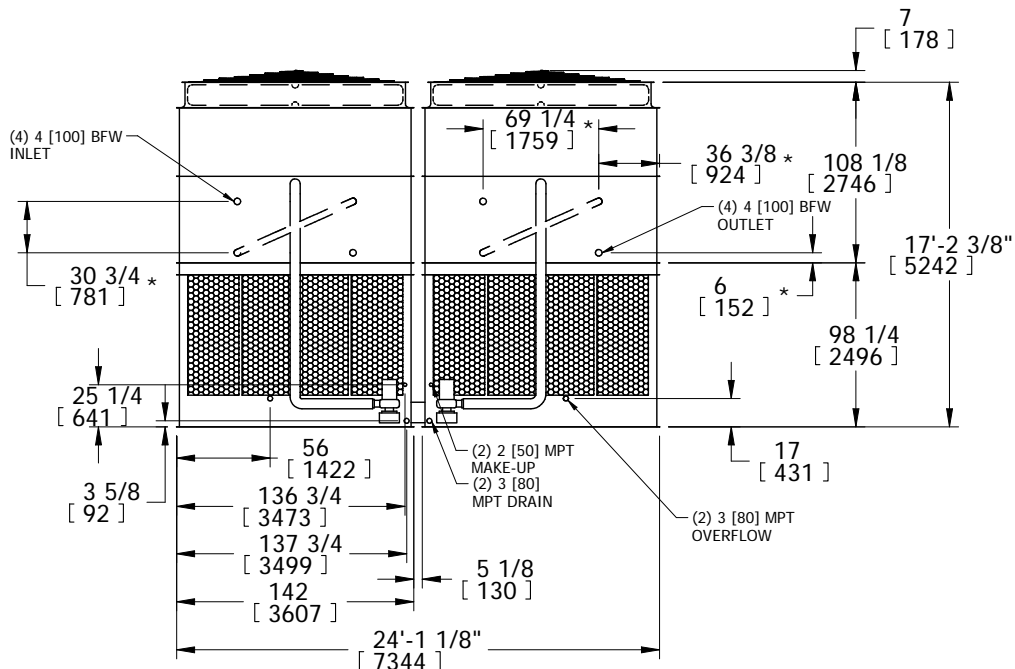

FACE 1

SHIPPING WEIGHT	58600 lbs+ [26585] kg+	OPERATING WEIGHT	86940 lbs+ [39440] kg+	HEAVIEST SECTION WEIGHT	25380 lbs+ [11515] kg+	NO. OF SHIPPING SECTIONS	4
-----------------	------------------------	------------------	------------------------	-------------------------	------------------------	--------------------------	---