

# EVAPCO, INC.



UNIT CLOSED CIRCUIT COOLER	MODEL # eco-ATWB-H 10-4J36-Z-U34	SCALE N.T.S.	DWG. # EGHTM36MR-DRB-SF	REV. -	DATE 4/4/2026	SERIAL #
-------------------------------	-------------------------------------	-----------------	----------------------------	-----------	------------------	----------

- NOTES:
- (M)- FAN MOTOR LOCATION
  - HEAVIEST SECTION IS COIL SECTION
  - MPT DENOTES MALE PIPE THREAD  
FPT DENOTES FEMALE PIPE THREAD  
BFW DENOTES BEVELED FOR WELDING
  - +UNIT WEIGHT DOES NOT INCLUDE ACCESSORIES (SEE ACCESSORY DRAWINGS)
  - MAKE-UP WATER PRESSURE  
20 psi MIN [137 kPa], 50 psi MAX [344 kPa]

6. DIMENSIONS LISTED AS FOLLOWS:  
ENGLISH IN  
[METRIC] [mm]
7. \* - APPROXIMATE DIMENSIONS DO NOT USE FOR PRE-FABRICATION OF CONNECTING PIPING.

**FACE 2  
PLAN VIEW**

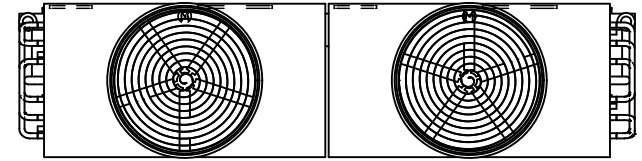

**FACE 1**

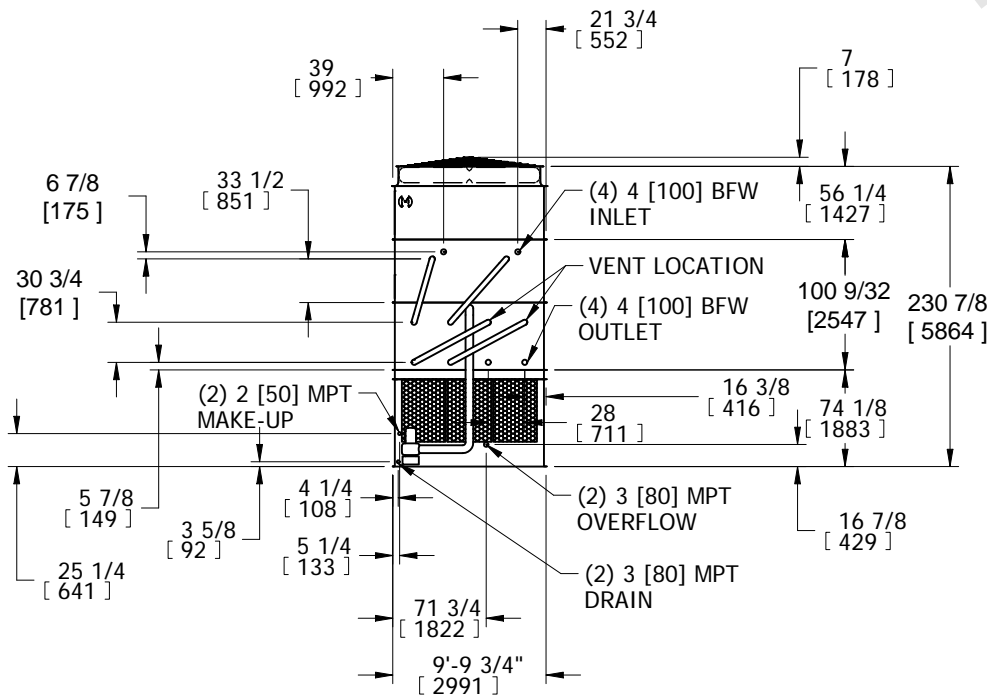

**FACE 2**

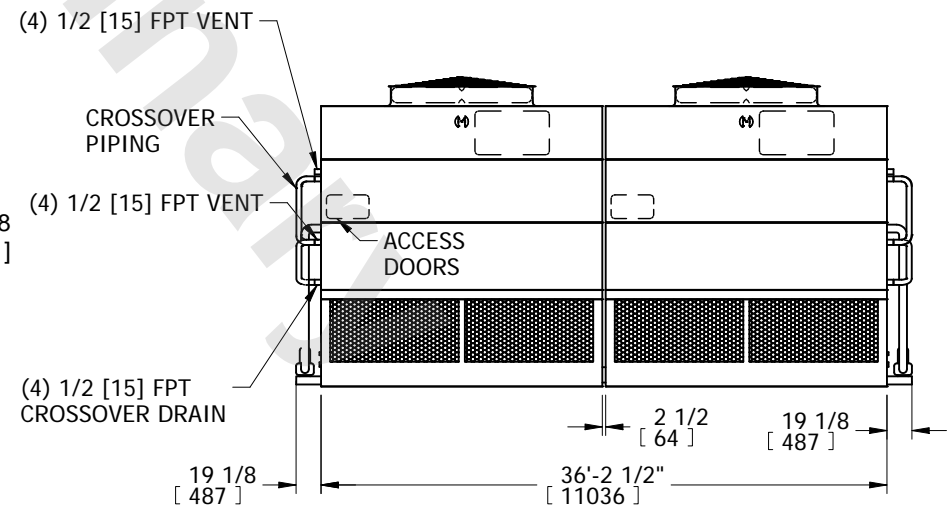

**FACE 1**

SHIPPING WEIGHT 64690 lbs+ [29345] kg+	OPERATING WEIGHT 86530 lbs+ [39250] kg+	HEAVIEST SECTION WEIGHT 24280 lbs+ [11015] kg+	NO. OF SHIPPING SECTIONS 6	DRAWN BY: SFR
---	--	---	-------------------------------	------------------