

EVAPCO, INC.



UNIT CLOSED CIRCUIT COOLER	MODEL # eco-ATWB-H 10-4I18-U34	SCALE N.T.S.	DWG. # EGHTM18MR-DRB-ST	REV. -	DATE 4/5/2026	SERIAL #
-------------------------------	-----------------------------------	-----------------	----------------------------	-----------	------------------	----------

- NOTES:
- (M)- FAN MOTOR LOCATION
 - HEAVIEST SECTION IS COIL SECTION
 - MPT DENOTES MALE PIPE THREAD
FPT DENOTES FEMALE PIPE THREAD
BFW DENOTES BEVELED FOR WELDING
 - +UNIT WEIGHT DOES NOT INCLUDE ACCESSORIES (SEE ACCESSORY DRAWINGS)
 - MAKE-UP WATER PRESSURE
20 psi MIN [137 kPa], 50 psi MAX [344 kPa]

- DIMENSIONS LISTED AS FOLLOWS:
ENGLISH IN
[METRIC] [mm]
- * - APPROXIMATE DIMENSIONS DO NOT USE FOR PRE-FABRICATION OF CONNECTING PIPING.

**FACE 2
PLAN VIEW**



FACE 1

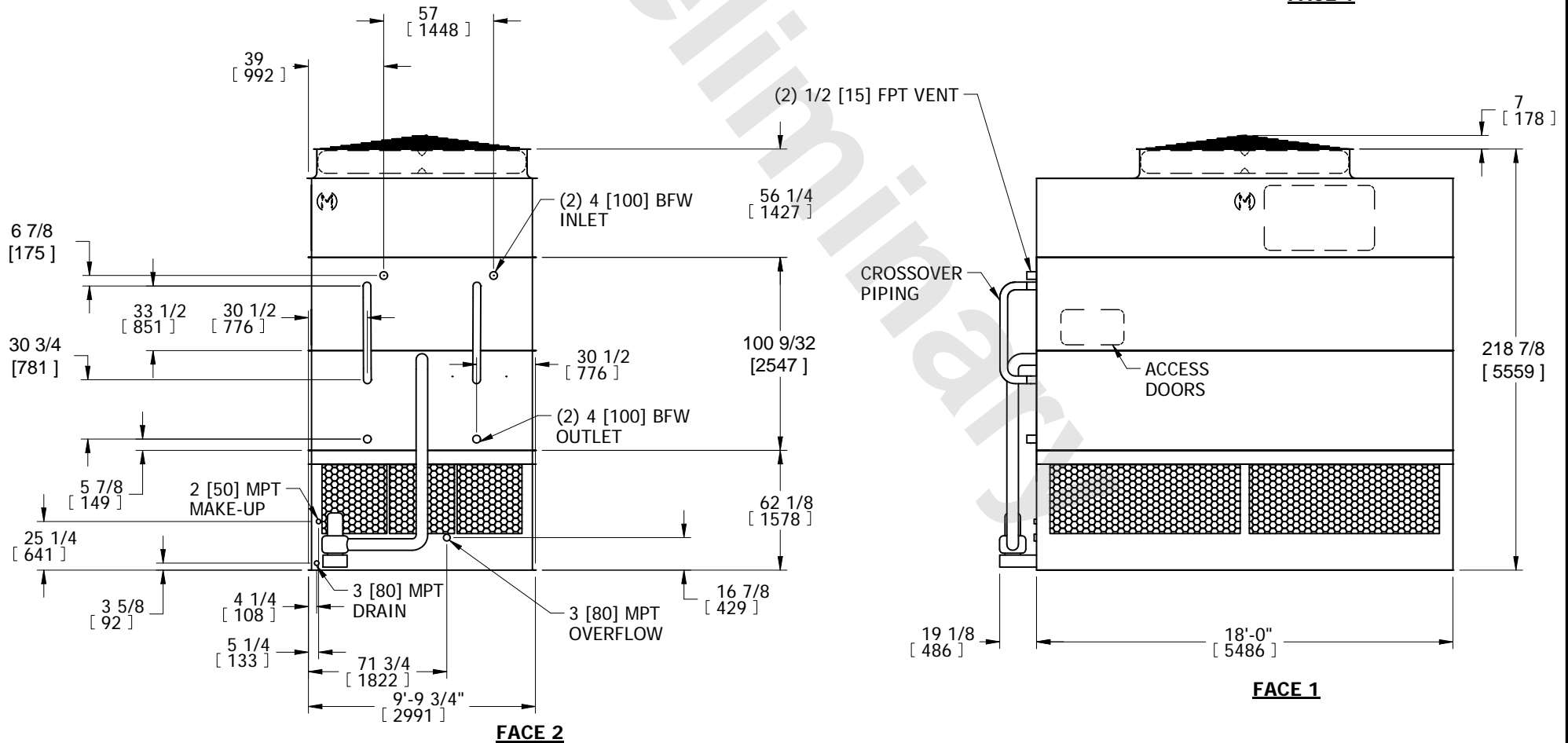

SHIPPING WEIGHT 32210 lbs+ [14615] kg+	OPERATING WEIGHT 43130 lbs+ [19565] kg+	HEAVIEST SECTION WEIGHT 24280 lbs+ [11015] kg+	NO. OF SHIPPING SECTIONS 3	DRAWN BY: SFR
---	--	---	-------------------------------	------------------