

EVAPCO, INC.



UNIT	CLOSED CIRCUIT COOLER	MODEL #	eco-ATWB-H 9-4L12-Z-U12	SCALE	N.T.S	DWG. #	EGH0912MR-DRC-SF	REV.	-	DATE	4/26/2026	SERIAL #	
------	-----------------------	---------	-------------------------	-------	-------	--------	------------------	------	---	------	-----------	----------	--

- NOTES:
- (M)- FAN MOTOR LOCATION
 - HEAVIEST SECTION IS COIL SECTION
 - MPT DENOTES MALE PIPE THREAD
FPT DENOTES FEMALE PIPE THREAD
BFW DENOTES BEVELED FOR WELDING
 - +UNIT WEIGHT DOES NOT INCLUDE ACCESSORIES (SEE ACCESSORY DRAWINGS)
 - MAKE-UP WATER PRESSURE
20 psi MIN [137 kPa], 50 psi MAX [344 kPa]

- DIMENSIONS LISTED AS FOLLOWS:
ENGLISH IN
[METRIC] [mm]
- * - APPROXIMATE DIMENSIONS DO NOT USE FOR PRE-FABRICATION OF CONNECTING PIPING.



**FACE 2
PLAN VIEW**

FACE 1

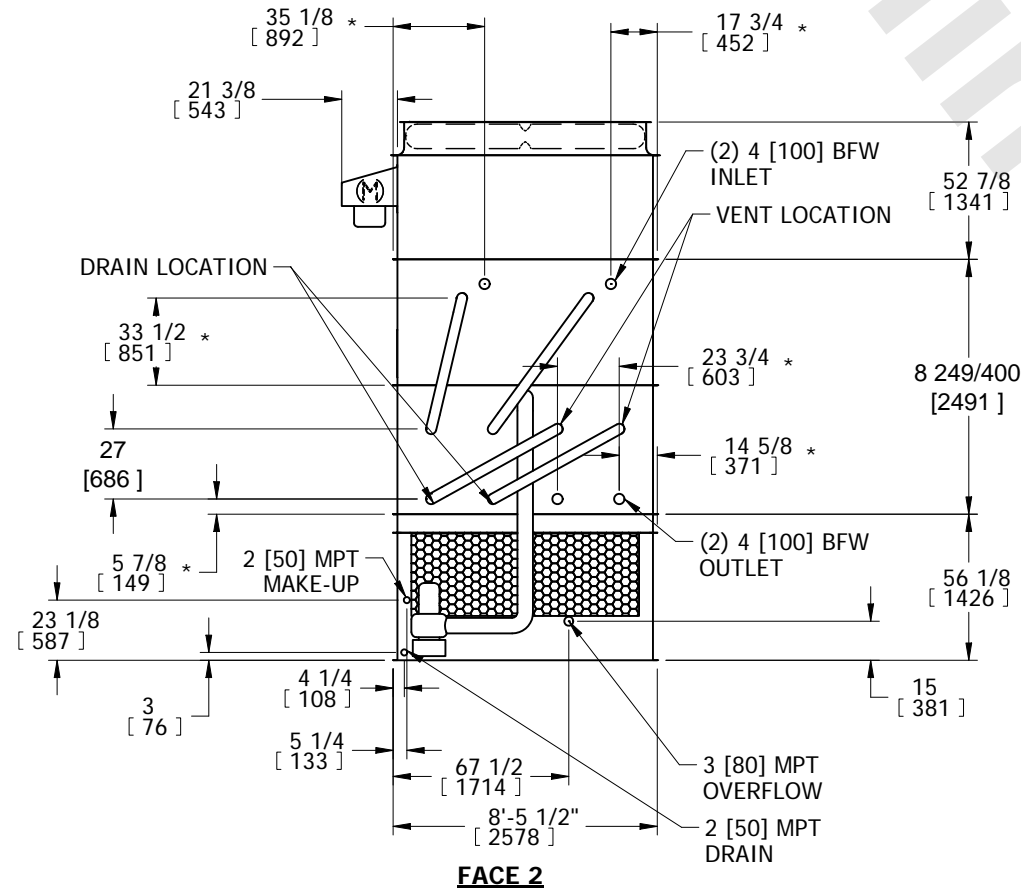

FACE 2

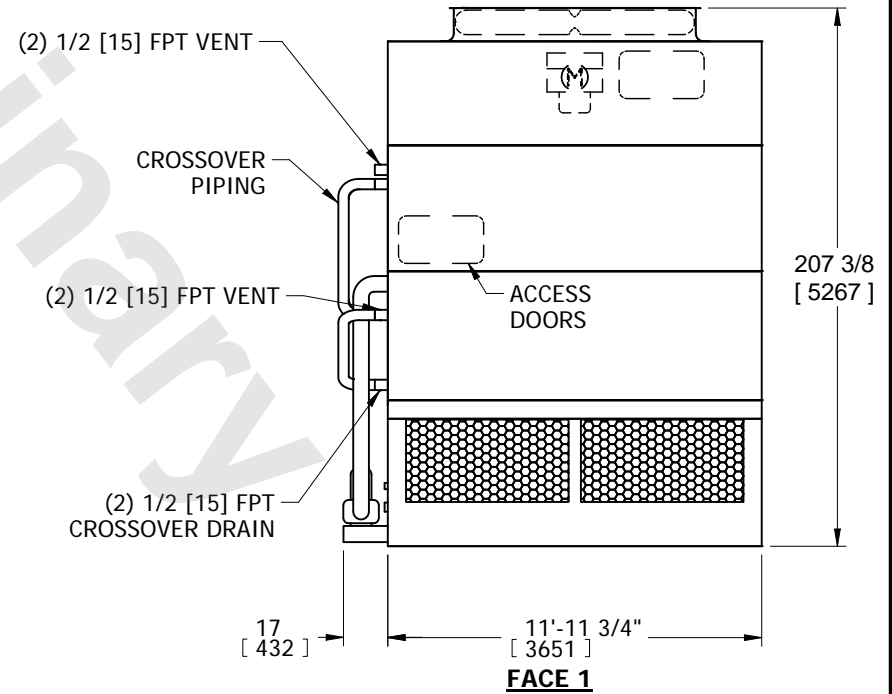

FACE 1

SHIPPING WEIGHT	16690 lbs+ [7575] kg+	OPERATING WEIGHT	22540 lbs+ [10225] kg+	HEAVIEST SECTION WEIGHT	12320 lbs+ [5585] kg+	NO. OF SHIPPING SECTIONS	3	DRAWN BY:	SFR
-----------------	-----------------------	------------------	------------------------	-------------------------	-----------------------	--------------------------	---	-----------	-----