

UNIT	COOLING TOWER
MODEL #	LPT-586
SCALE	NTS

# EVAPCO, INC.



DWG. #	TV05063F-DRE-ST	REV.	-
SERIAL #		DATE	7/4/2026

- NOTES:
- (M)- FAN MOTOR LOCATION
  - MPT DENOTES MALE PIPE THREAD  
FPT DENOTES FEMALE PIPE THREAD  
BFW DENOTES BEVELED FOR WELDING  
GVD DENOTES GROOVED  
FLG DENOTES FLANGE
  - + UNIT WEIGHT DOES NOT INCLUDE ACCESSORIES (SEE SEPARATE DRAWINGS FOR ACCESSORIES)
  - 3/4" DIA. MOUNTING HOLES. REFER TO RECOMMENDED STEEL SUPPORT DRAWING
  - MAKE-UP WATER PRESSURE-20 psi MIN, 50 psi MAX
  - DIMENSIONS LISTED AS FOLLOWS:  
ENGLISH FT-IN  
[METRIC] MM

**FACE B  
PLAN VIEW**

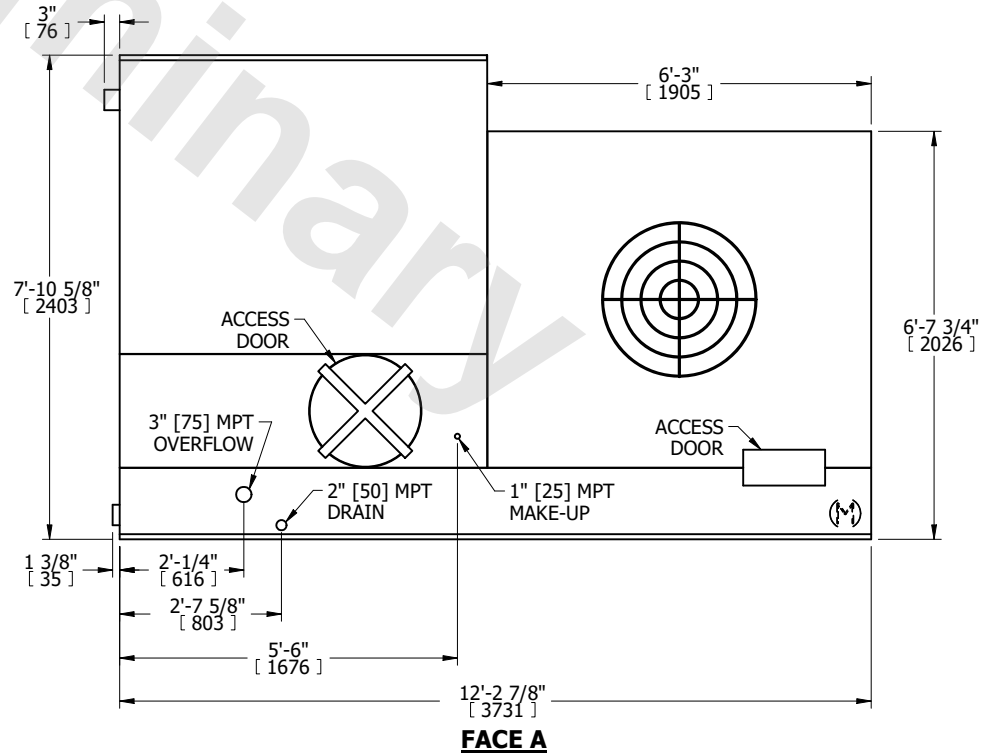
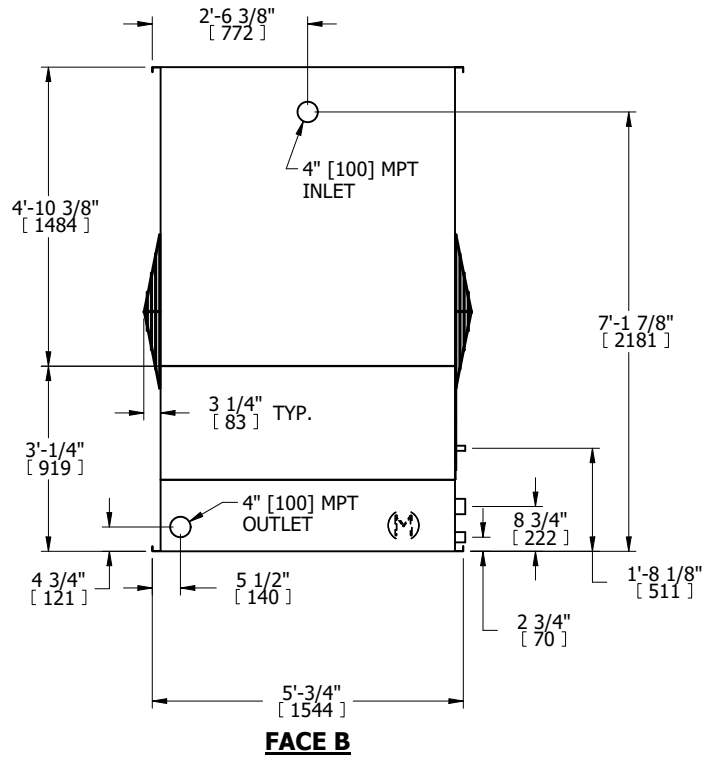

SHIPPING WEIGHT	2520 lbs+ [1145] kg+	OPERATING WEIGHT	4240 lbs+ [1925] kg+	HEAVIEST SECTION WEIGHT	2520 lbs+ [1145] kg+	NO. OF SHIPPING SECTIONS	1	DRAWN BY:	JLG
-----------------	----------------------	------------------	----------------------	-------------------------	----------------------	--------------------------	---	-----------	-----