

UNIT	COOLING TOWER	
MODEL #	LPT-596	SCALE NTS

EVAPCO, INC.



DWG. #	TV05063F-DRE-ST	REV.	-
SERIAL #		DATE	7/4/2026

- NOTES:
- (M)- FAN MOTOR LOCATION
 - MPT DENOTES MALE PIPE THREAD
FPT DENOTES FEMALE PIPE THREAD
BFW DENOTES BEVELED FOR WELDING
GVD DENOTES GROOVED
FLG DENOTES FLANGE
 - + UNIT WEIGHT DOES NOT INCLUDE ACCESSORIES (SEE SEPARATE DRAWINGS FOR ACCESSORIES)
 - 3/4" DIA. MOUNTING HOLES. REFER TO RECOMMENDED STEEL SUPPORT DRAWING
 - MAKE-UP WATER PRESSURE-20 psi MIN, 50 psi MAX
 - DIMENSIONS LISTED AS FOLLOWS:
ENGLISH FT-IN
[METRIC] MM

**FACE B
PLAN VIEW**

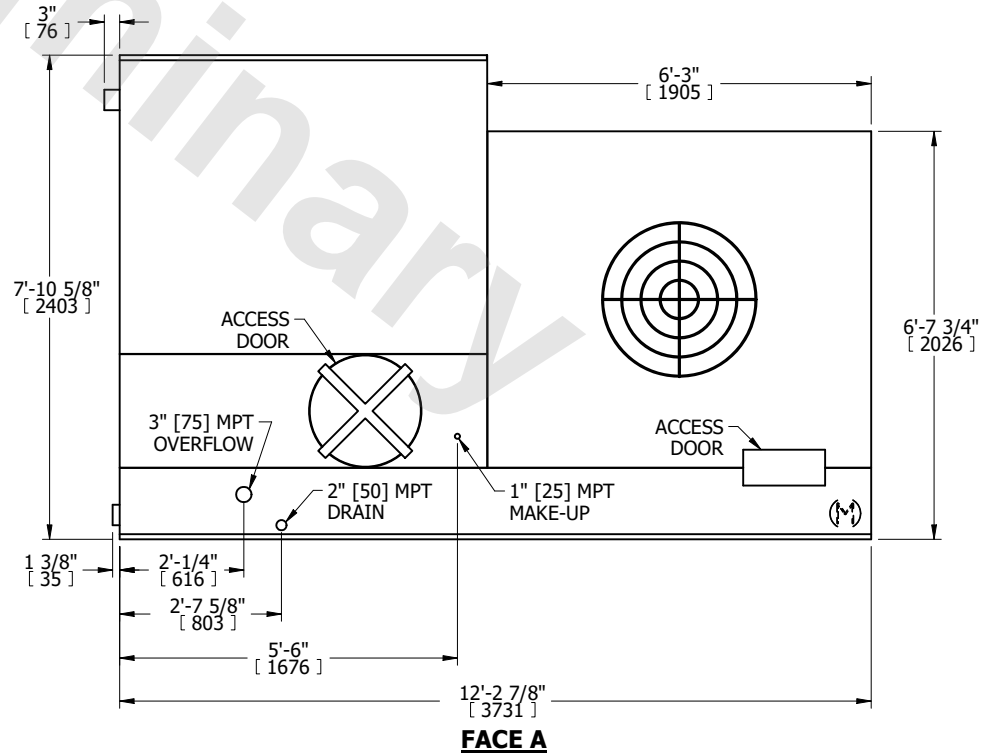
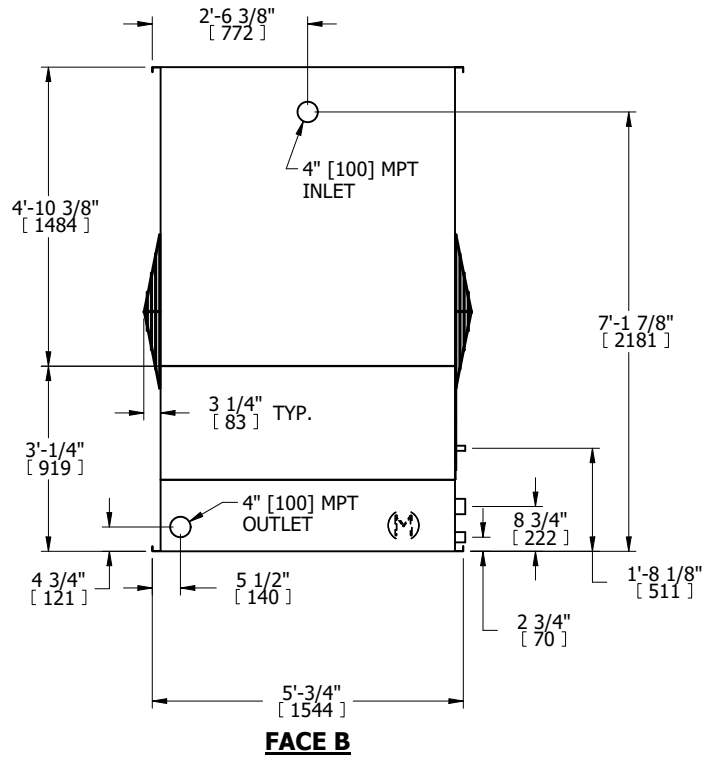

SHIPPING WEIGHT	2560 lbs+ [1165] kg+	OPERATING WEIGHT	4280 lbs+ [1945] kg+	HEAVIEST SECTION WEIGHT	2560 lbs+ [1165] kg+	NO. OF SHIPPING SECTIONS	1	DRAWN BY:	JLG
-----------------	----------------------	------------------	----------------------	-------------------------	----------------------	--------------------------	---	-----------	-----