

UNIT	COOLING TOWER	
MODEL #	AXS 12-19N22	SCALE



DWG. #	AX122217-DRA-ST	REV.	-
SERIAL #		DATE	4/29/2026

- NOTES:
1. (M)- FAN MOTOR LOCATION
 2. HEAVIEST SECTION IS UPPER SECTION
 3. MPT DENOTES MALE PIPE THREAD
FPT DENOTES FEMALE PIPE THREAD
BFW DENOTES BEVELED FOR WELDING
GVD DENOTES GROOVED
 4. +UNIT WEIGHT DOES NOT INCLUDE ACCESSORIES (SEE ACCESSORY DRAWINGS)
 5. MAKE-UP WATER PRESSURE
20 psi MIN [137 kPa], 50 psi MAX [344 kPa]
 6. 3/4" DIA. MOUNTING HOLES. REFER TO RECOMMENDED STEEL SUPPORT DRAWING.
 7. DIMENSIONS LISTED AS FOLLOWS: ENGLISH IN [METRIC] [mm]

**FACE B
PLAN VIEW**



FACE B

FACE A

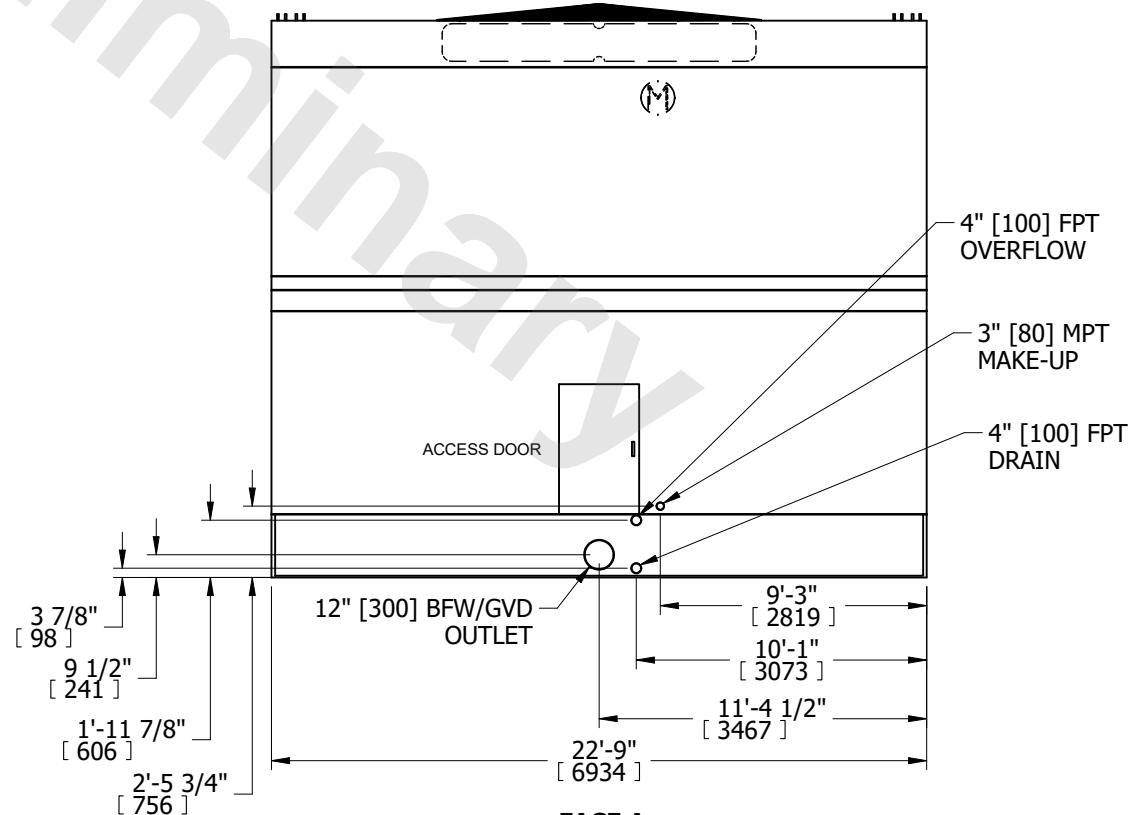

FACE A

SHIPPING WEIGHT	16840 lbs+ [7640] kg+	OPERATING WEIGHT	37780 lbs+ [17140] kg+	HEAVIEST SECTION WEIGHT	9660 lbs+ [4385] kg+	NO. OF SHIPPING SECTIONS	2	DRAWN BY:	JLM
-----------------	-----------------------	------------------	------------------------	-------------------------	----------------------	--------------------------	---	-----------	-----