

UNIT	COOLING TOWER	
MODEL #	AXS 12-19O22	SCALE

EVAPCO, INC.

DWG. #	AX122217-DRA-ST	REV.	-
SERIAL #		DATE	6/25/2026

- NOTES:
- (M)- FAN MOTOR LOCATION
 - HEAVIEST SECTION IS UPPER SECTION
 - MPT DENOTES MALE PIPE THREAD
FPT DENOTES FEMALE PIPE THREAD
BFW DENOTES BEVELED FOR WELDING
GVD DENOTES GROOVED
 - +UNIT WEIGHT DOES NOT INCLUDE ACCESSORIES (SEE ACCESSORY DRAWINGS)
 - MAKE-UP WATER PRESSURE
20 psi MIN [137 kPa], 50 psi MAX [344 kPa]
 - 3/4" DIA. MOUNTING HOLES. REFER TO RECOMMENDED STEEL SUPPORT DRAWING.
 - DIMENSIONS LISTED AS FOLLOWS: ENGLISH IN [METRIC] [mm]

**FACE B
PLAN VIEW**



FACE B

FACE A

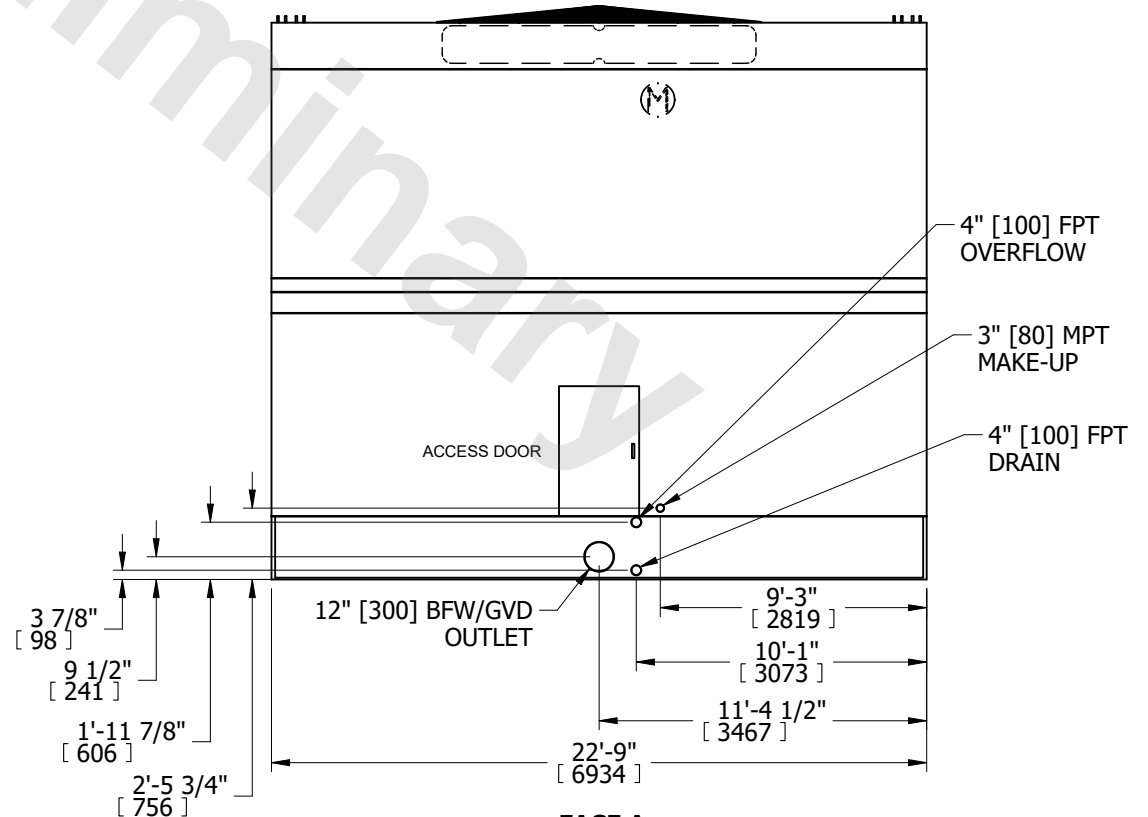

FACE A

SHIPPING WEIGHT 16940 lbs+ [7685] kg+

OPERATING WEIGHT 37890 lbs+ [17190] kg+

HEAVIEST SECTION WEIGHT 9760 lbs+ [4430] kg+

NO. OF SHIPPING SECTIONS 2

DRAWN BY: JLM