

UNIT	<b>COOLING TOWER</b>	
MODEL #	AXS 14-22O24	SCALE

# EVAPCO, INC.



DWG. #	AX142420-DRA-ST	REV.	-
SERIAL #		DATE	4/28/2026

- NOTES:
- (M)- FAN MOTOR LOCATION
  - HEAVIEST SECTION IS UPPER SECTION
  - MPT DENOTES MALE PIPE THREAD  
FPT DENOTES FEMALE PIPE THREAD  
BFW DENOTES BEVELED FOR WELDING  
GVD DENOTES GROOVED
  - +UNIT WEIGHT DOES NOT INCLUDE ACCESSORIES (SEE ACCESSORY DRAWINGS)
  - MAKE-UP WATER PRESSURE  
20 psi MIN [137 kPa], 50 psi MAX [344 kPa]
  - 3/4" DIA. MOUNTING HOLES. REFER TO RECOMMENDED STEEL SUPPORT DRAWING.
  - DIMENSIONS LISTED AS FOLLOWS: ENGLISH IN [METRIC] [mm]

**FACE B  
PLAN VIEW**



**FACE B**



**FACE A**

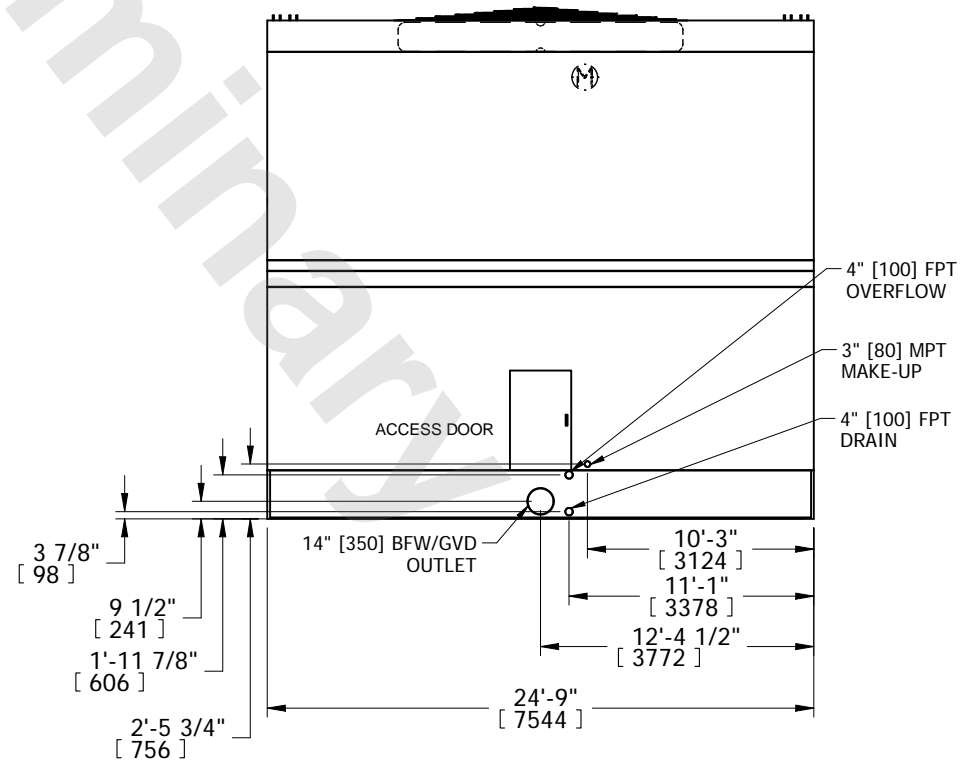

**FACE A**

SHIPPING WEIGHT	22800 lbs+ [10345] kg+	OPERATING WEIGHT	49450 lbs+ [22435] kg+	HEAVIEST SECTION WEIGHT	13050 lbs+ [5920] kg+	NO. OF SHIPPING SECTIONS	2	DRAWN BY:	SLR
-----------------	------------------------	------------------	------------------------	-------------------------	-----------------------	--------------------------	---	-----------	-----