

UNIT	CONDENSER	
MODEL #	LRC-29	SCALE NTS

# EVAPCO, INC.

DWG. #	WV030604-DRC-ST	REV.	-
SERIAL #		DATE	6/9/2026

- NOTES:
- (M)- FAN MOTOR LOCATION
  - MPT DENOTES MALE PIPE THREAD  
FPT DENOTES FEMALE PIPE THREAD  
BFW DENOTES BEVELED FOR WELDING  
GVD DENOTES GROOVED  
FLG DENOTES FLANGE  
PE DENOTES PLAIN END
  - +UNIT WEIGHT DOES NOT INCLUDE ACCESSORIES (SEE ACCESSORY DRAWINGS)
  - 3/4" [19mm] DIA. MOUNTING HOLES. REFER TO RECOMMENDED STEEL SUPPORT DRAWING
  - DIMENSIONS LISTED AS FOLLOWS: ENGLISH FT IN [METRIC] [mm]
  - \* - APPROXIMATE DIMENSIONS DO NOT USE FOR PRE-FABRICATION OF CONNECTING PIPING
  - MAKE-UP WATER PRESSURE  
20 psi [137 kPa] MIN, 50 psi [344 kPa] MAX

**FACE B  
PLAN VIEW**

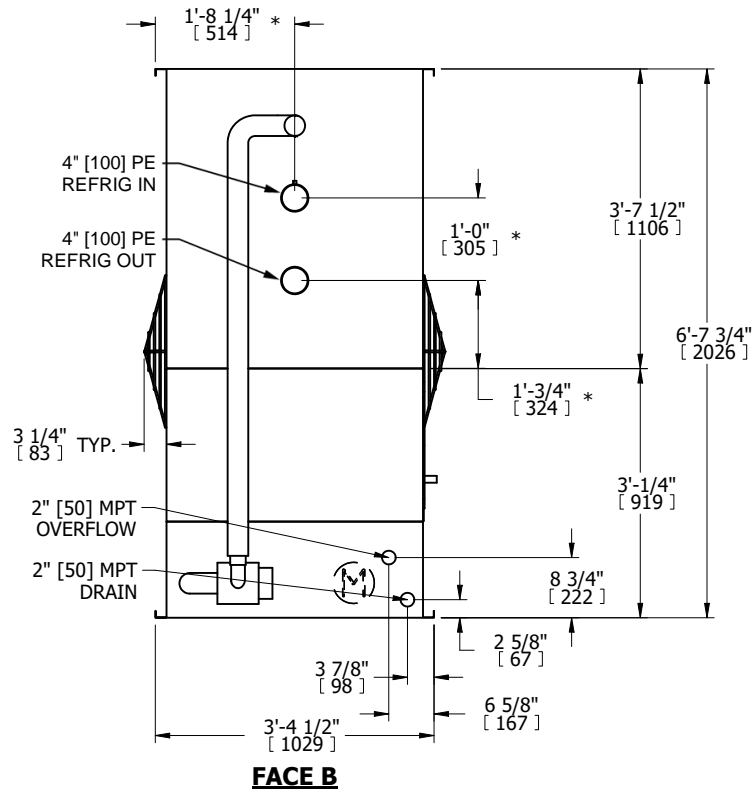

**FACE C**

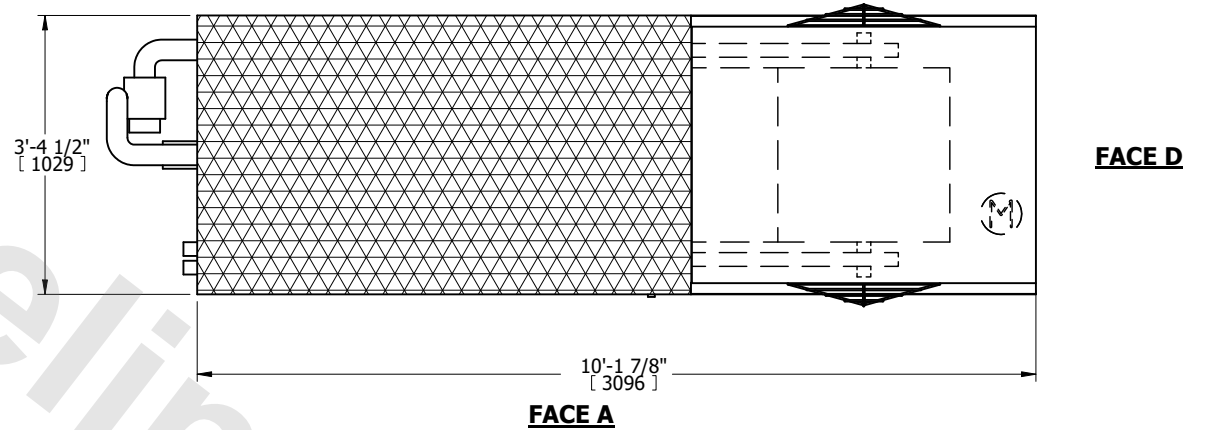

**FACE A**

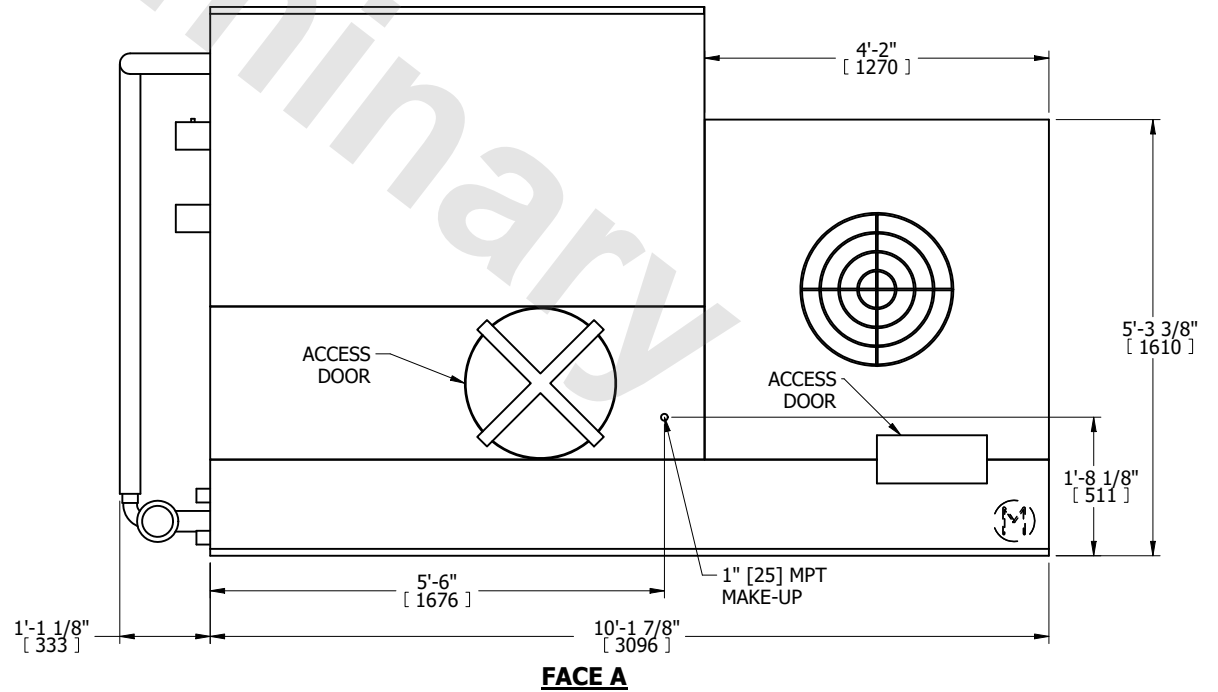

**FACE A**

SHIPPING WEIGHT	2320 lbs+ [1055] kg+	OPERATING WEIGHT	3360 lbs+ [1525] kg+	HEAVIEST SECTION WEIGHT	2320 lbs+ [1055] kg+	NO. OF SHIPPING SECTIONS	1	DRAWN BY:	TLS
-----------------	----------------------	------------------	----------------------	-------------------------	----------------------	--------------------------	---	-----------	-----