

UNIT	CONDENSER	
MODEL #	LRC-91	SCALE NTS



DWG. #	WV050608-DRC-ST	REV.	-
SERIAL #		DATE	6/9/2026

**NOTES:**

1. (M)- FAN MOTOR LOCATION
2. MPT DENOTES MALE PIPE THREAD  
FPT DENOTES FEMALE PIPE THREAD  
BFW DENOTES BEVELED FOR WELDING  
GVD DENOTES GROOVED  
FLG DENOTES FLANGE  
PE DENOTES PLAIN END
3. +UNIT WEIGHT DOES NOT INCLUDE ACCESSORIES (SEE ACCESSORY DRAWINGS)
4. 3/4" [19mm] DIA. MOUNTING HOLES. REFER TO RECOMMENDED STEEL SUPPORT DRAWING
5. DIMENSIONS LISTED AS FOLLOWS: ENGLISH FT IN [METRIC] [mm]
6. \* - APPROXIMATE DIMENSIONS DO NOT USE FOR PRE-FABRICATION OF CONNECTING PIPING
7. MAKE-UP WATER PRESSURE  
20 psi [137 kPa] MIN, 50 psi [344 kPa] MAX

**FACE B**  
**PLAN VIEW**

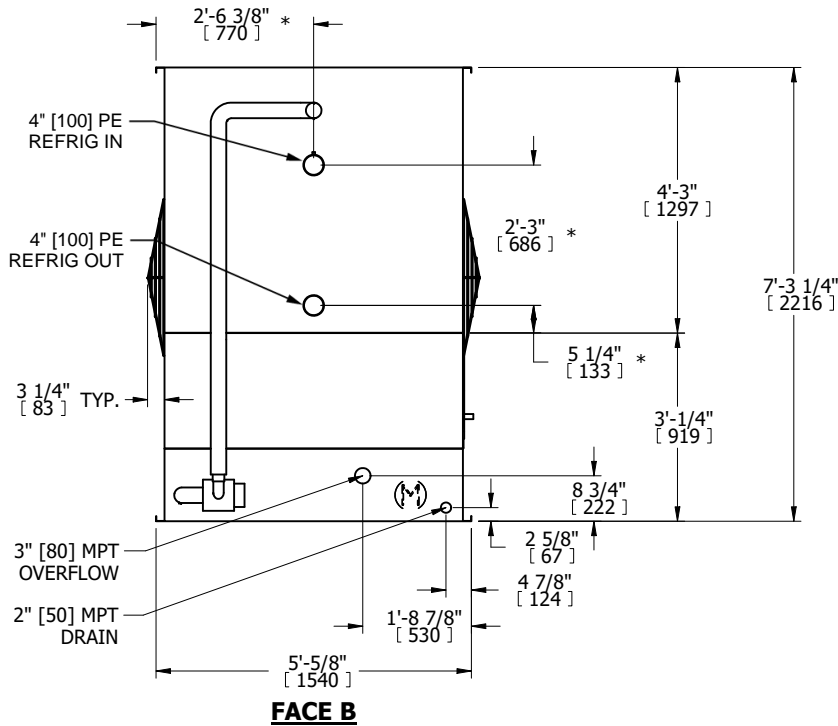

**FACE C**

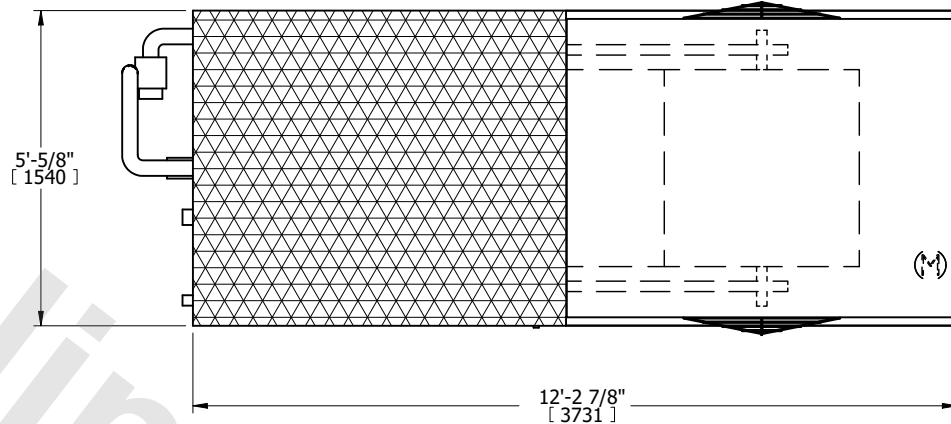

**FACE D**

**FACE A**

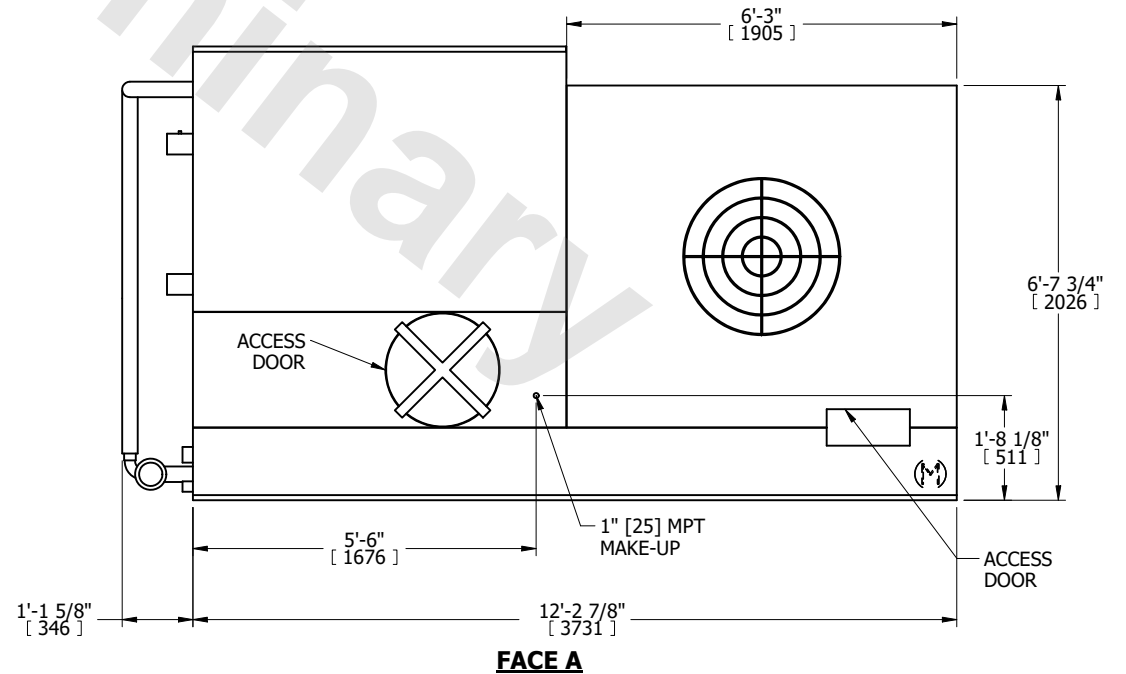

SHIPPING WEIGHT	4580 lbs+ [2080] kg+	OPERATING WEIGHT	6490 lbs+ [2945] kg+	HEAVIEST SECTION WEIGHT	4580 lbs+ [2080] kg+	NO. OF SHIPPING SECTIONS	1	DRAWN BY:	TLS
-----------------	----------------------	------------------	----------------------	-------------------------	----------------------	--------------------------	---	-----------	-----