

EVAPCO, INC.



UNIT EVAPORATIVE CONDENSER	MODEL # PMC-811E	SCALE N.T.S.	DWG. # CE122010-DRB-ST	REV. -	DATE 7/18/2025	SERIAL #
--------------------------------------	---------------------	-----------------	---------------------------	-----------	-------------------	----------

- NOTES:
- (M)- FAN MOTOR LOCATION
 - HEAVIEST SECTION IS UPPER SECTION
 - MPT DENOTES MALE PIPE THREAD
FPT DENOTES FEMALE PIPE THREAD
BFW DENOTES BEVELED FOR WELDING
 - +UNIT WEIGHT DOES NOT INCLUDE ACCESSORIES (SEE ACCESSORY DRAWINGS)
 - 3/4" DIA. MOUNTING HOLES. REFER TO RECOMMENDED STEEL SUPPORT DRAWING.
 - MAKE-UP WATER PRESSURE
20 psi MIN [137 kPa], 50 psi MAX [344 kPa]
 - * -APPROXIMATE DIMENSIONS DO NOT USE FOR PRE-FABRICATION OF CONNECTING PIPING
 - DIMENSIONS LISTED AS FOLLOWS: ENGLISH IN [METRIC] [mm]

**FACE 1
PLAN VIEW**

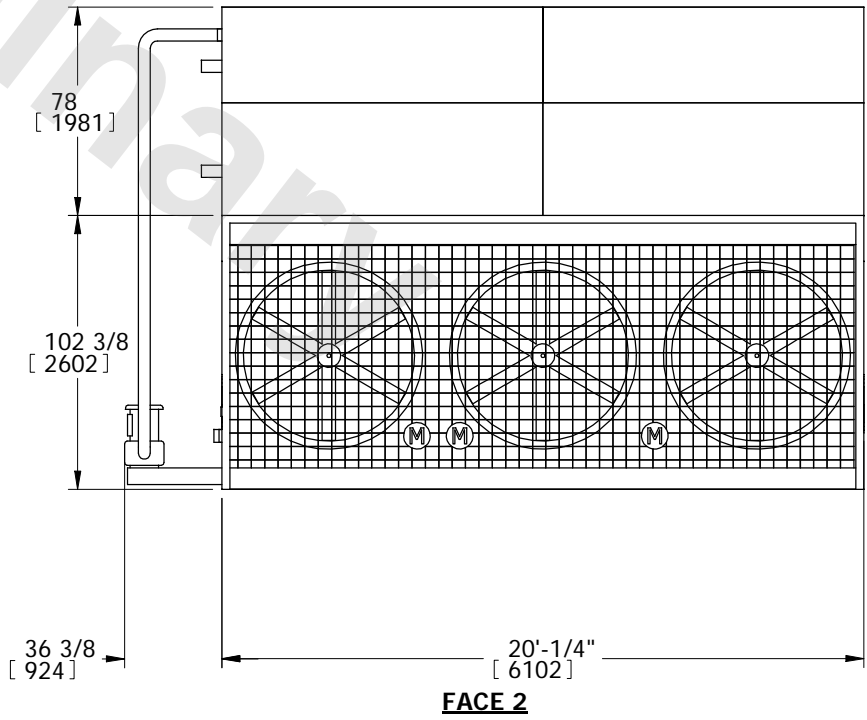
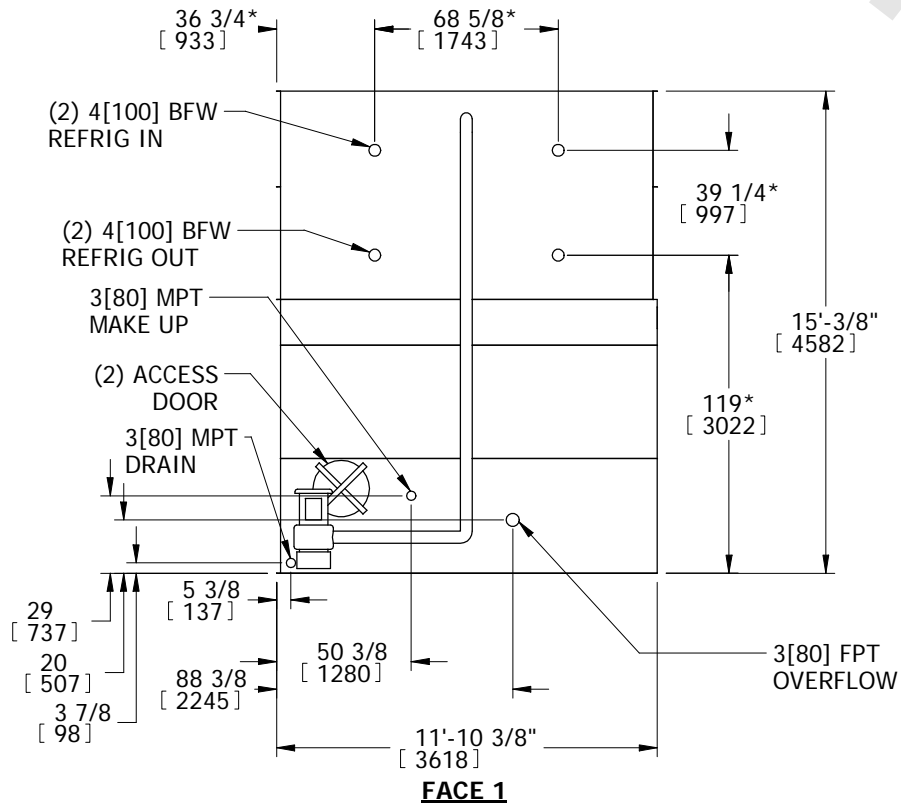
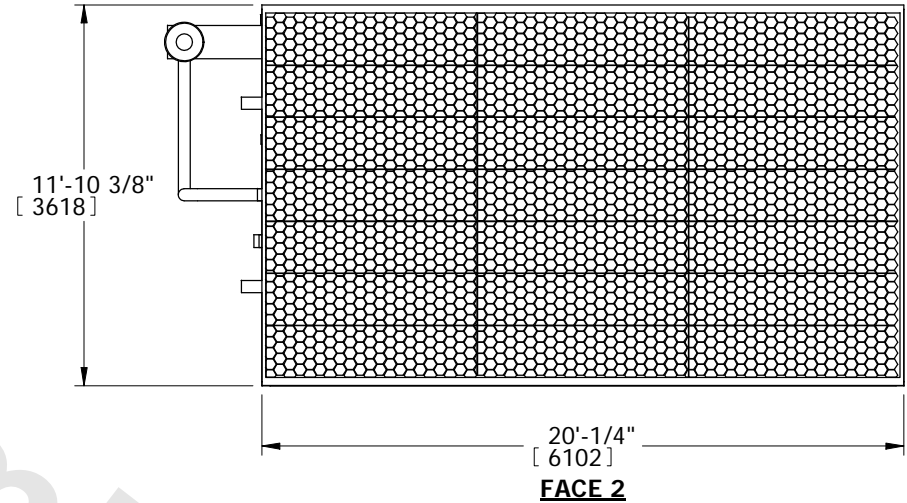

SHIPPING WEIGHT 32550 lbs+ [14764] kg+	OPERATING WEIGHT 42310 lbs+ [19191] kg+	HEAVIEST SECTION WEIGHT 24490 lbs+ [11108] kg+	NO. OF SHIPPING SECTIONS 2
---	--	---	-------------------------------