

CONFIDENTIAL

This document is the property of Evapco, Inc. It should not be copied or disclosed without prior written authorization.

EVAPCO, INC.



| | | | | | |
|----------|------------------------------|--------------|--------------------|--------|---------------|
| CUSTOMER | MODEL # SSTMB2-1683E0200C1MA | SCALE N.T.S. | DWG. # STMC2-SE-14 | REV. 0 | DATE 5/2/2026 |
|----------|------------------------------|--------------|--------------------|--------|---------------|



NOTES:

- 1) * = HANGER HOLE LOCATION.
- 2) RIGHT HAND MODEL SHOWN.
- 3) HANGER HOLES ARE FOR 3/4 INCH THREADED ROD.
- 4) WATER DEFROST ADDS 1 3/4" INCHES TO HEIGHT OF STANDARD UNIT AND CHANGES DRAIN SIZE.
- 5) ALL DIMENSIONS ARE FOR REFERENCE AND SHOULD NOT BE USED FOR PREFABRICATION OF PIPING OR SUPPORTS.

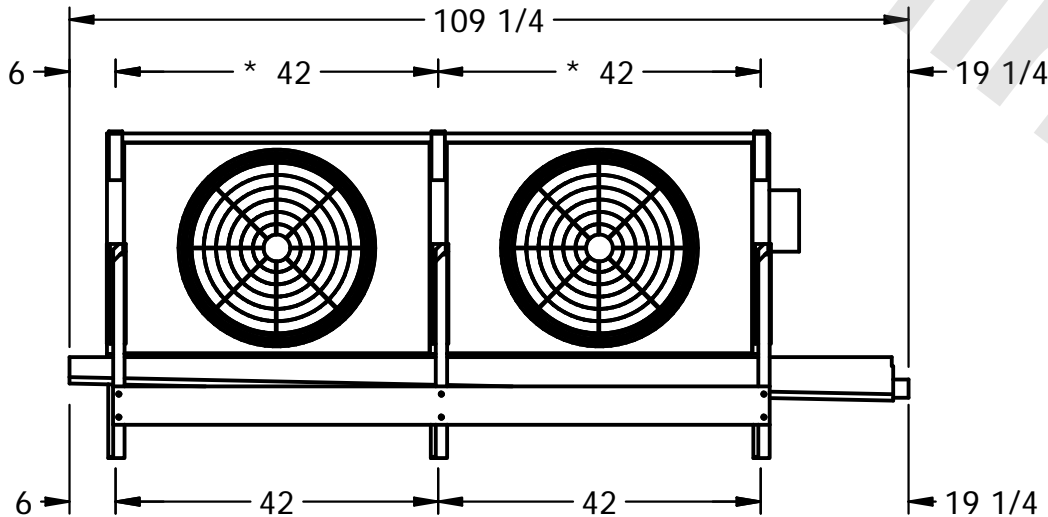

| | | | |
|---------|------|--------------------------|---------------------------|
| PROJECT | ROOM | SHIPPING WEIGHT 1020 lbs | OPERATING WEIGHT 1180 lbs |
|---------|------|--------------------------|---------------------------|