

CONFIDENTIAL

This document is the property of Evapco, Inc. It should not be copied or disclosed without prior written authorization.

EVAPCO, INC.



CUSTOMER	MODEL # SSTMB4-28104E0025C1KA	SCALE N.T.S.	DWG. # STMC4-SE-14	REV. 0	DATE 7/5/2026
----------	-------------------------------	--------------	--------------------	--------	---------------

NOTES:

- 1) * = HANGER HOLE LOCATION.
- 2) RIGHT HAND MODEL SHOWN.
- 3) HANGER HOLES ARE FOR 3/4 INCH THREADED ROD.
- 4) WATER DEFROST ADDS 1 3/4" INCHES TO HEIGHT OF STANDARD UNIT AND CHANGES DRAIN SIZE.
- 5) ALL DIMENSIONS ARE FOR REFERENCE AND SHOULD NOT BE USED FOR PREFABRICATION OF PIPING OR SUPPORTS.

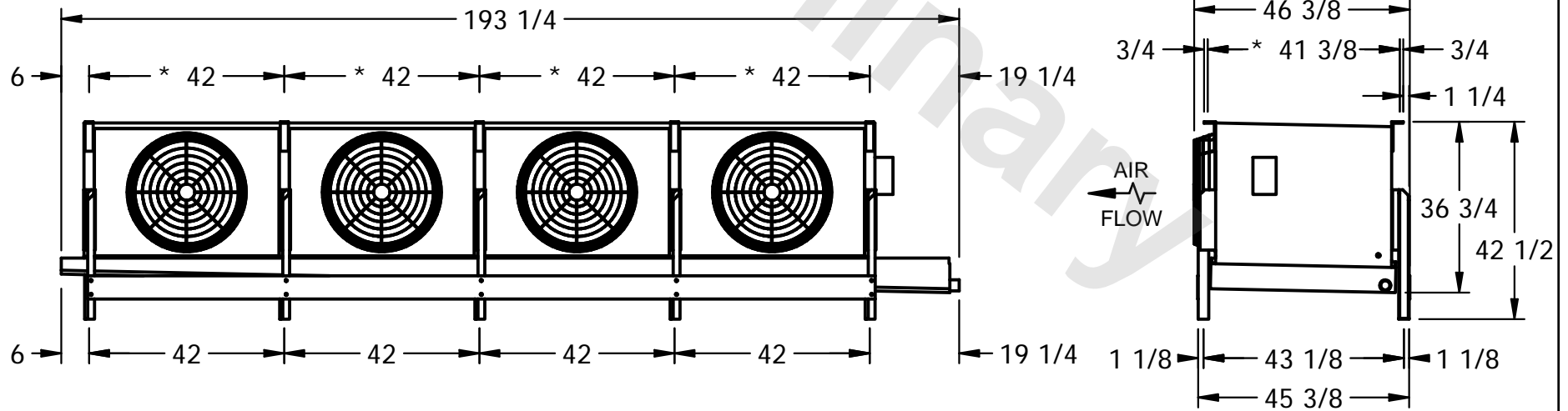

PROJECT	ROOM	SHIPPING WEIGHT 1950 lbs	OPERATING WEIGHT 2360 lbs
---------	------	--------------------------	---------------------------