

EVAPCO, INC.



| | | | | | | |
|--------------------------------------|---------------------|-------|----------------------------|-----------|-------------------|----------|
| UNIT EVAPORATIVE CONDENSER | MODEL # PHC-S750 | SCALE | DWG. # HCS122414-DRC-ST | REV. - | DATE 5/17/2026 | SERIAL # |
|--------------------------------------|---------------------|-------|----------------------------|-----------|-------------------|----------|

NOTES:

- (M)- FAN MOTOR LOCATION
- HEAVIEST SECTION IS UPPER SECTION
- MPT DENOTES MALE PIPE THREAD
FPT DENOTES FEMALE PIPE THREAD
BFW DENOTES BEVELED FOR WELDING
GVD DENOTES GROOVED
- +UNIT WEIGHT DOES NOT INCLUDE ACCESSORIES (SEE ACCESSORY DRAWINGS)
- MAKE-UP WATER PRESSURE
20 psi MIN [137 kPa], 50 psi MAX [344 kPa]
- 3/4" DIA. MOUNTING HOLES. REFER TO RECOMMENDED STEEL SUPPORT DRAWING.
- *- APPROXIMATE DIMENSIONS DO NOT USE FOR PRE-FABRICATION OF CONNECTION PIPING.
- **-UNITS WITH 20HP PER FAN REQUIRE A TALLER FAN CYLINDER, ADD 5" TO THESE DIMENSIONS.
- DIMENSIONS LISTED AS FOLLOWS: ENGLISH IN [METRIC] [mm]

**FACE 2
PLAN VIEW**

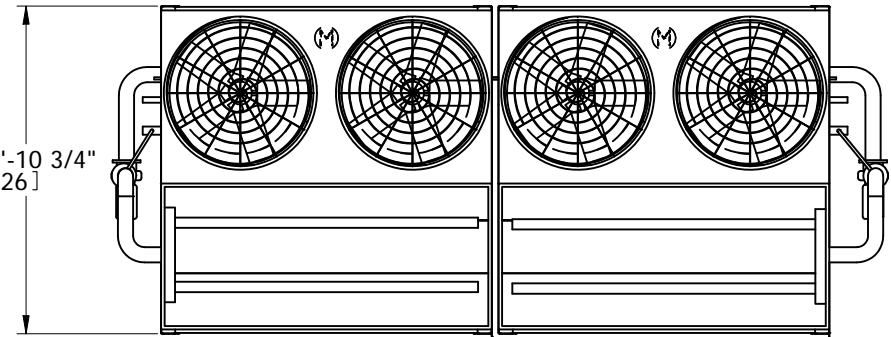

FACE 1

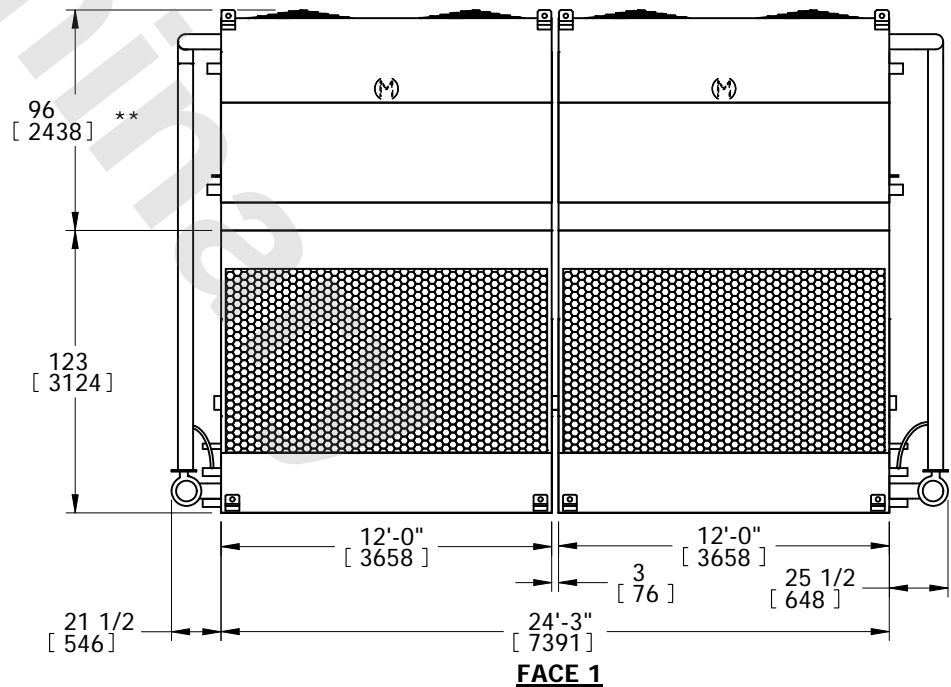
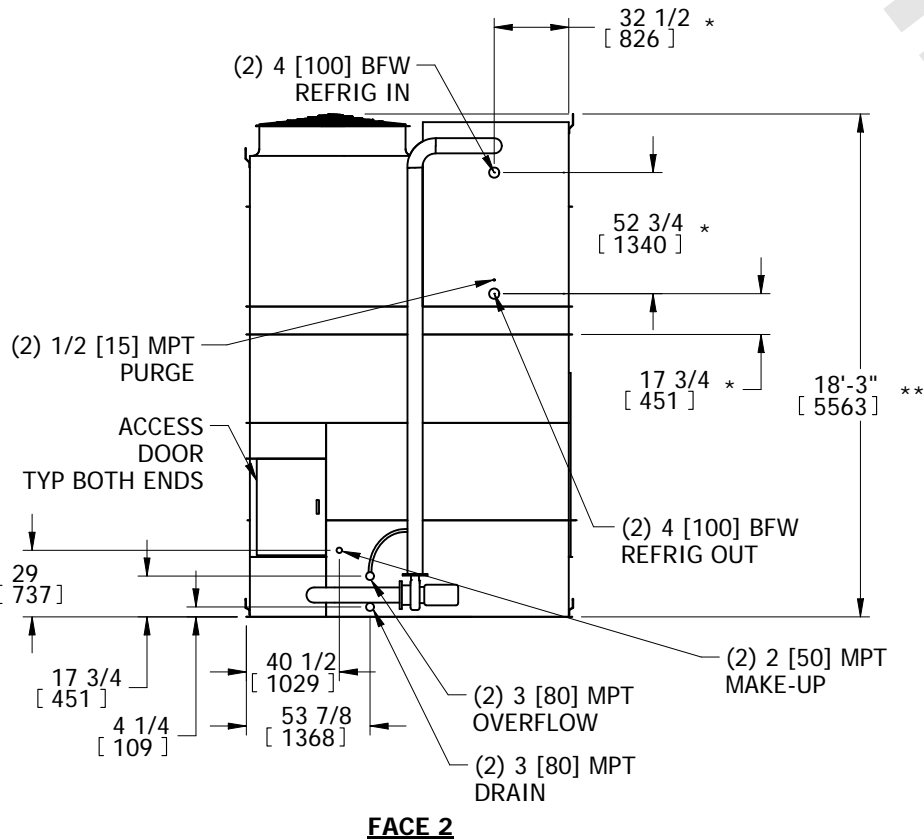

| | | | | |
|---|--|--|-------------------------------|------------------|
| SHIPPING WEIGHT 33340 lbs+ [15125] kg+ | OPERATING WEIGHT 44560 lbs+ [20215] kg+ | HEAVIEST SECTION WEIGHT 11510 lbs+ [5225] kg+ | NO. OF SHIPPING SECTIONS 4 | DRAWN BY: TLS |
|---|--|--|-------------------------------|------------------|