

EVAPCO, INC.



UNIT EVAPORATIVE CONDENSER	MODEL # PHC-D1580	SCALE	DWG. # HCD282610-DRC-ST	REV. -	DATE 5/17/2026	SERIAL #
--------------------------------------	----------------------	-------	----------------------------	-----------	-------------------	----------

- NOTES:
- (M)- FAN MOTOR LOCATION
 - HEAVIEST SECTION IS UPPER SECTION
 - MPT DENOTES MALE PIPE THREAD
FPT DENOTES FEMALE PIPE THREAD
BFW DENOTES BEVELED FOR WELDING
GVD DENOTES GROOVED
 - +UNIT WEIGHT DOES NOT INCLUDE ACCESSORIES (SEE ACCESSORY DRAWINGS)
 - MAKE-UP WATER PRESSURE
20 psi MIN [137 kPa], 50 psi MAX [344 kPa]
 - 3/4" DIA. MOUNTING HOLES. REFER TO RECOMMENDED STEEL SUPPORT DRAWING.
 - *- APPROXIMATE DIMENSIONS DO NOT USE FOR PRE-FABRICATION OF CONNECTION PIPING.
 - DIMENSIONS LISTED AS FOLLOWS: ENGLISH IN [METRIC] [mm]

**FACE 2
PLAN VIEW**

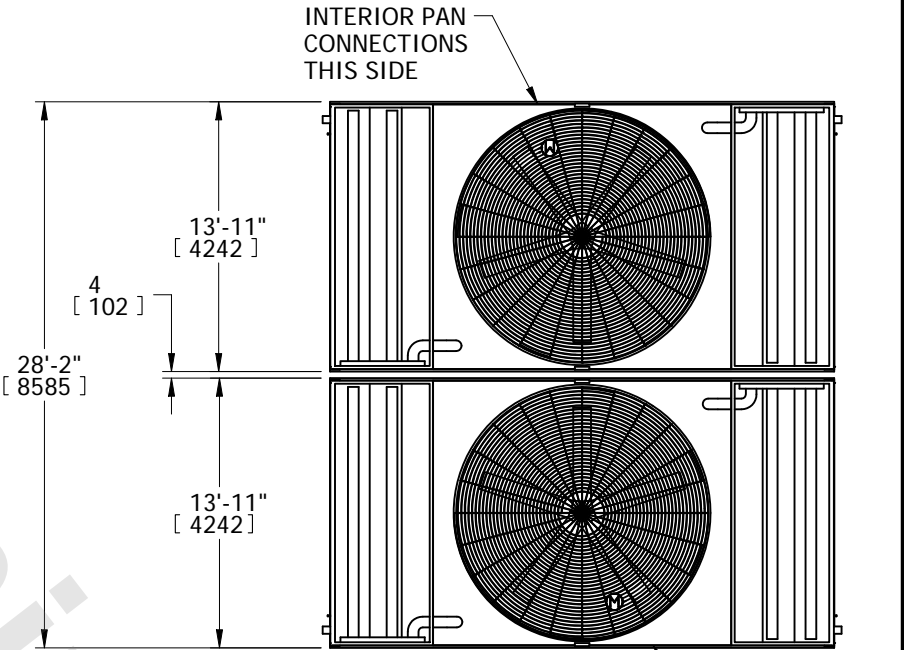

FACE 1
INTERIOR PAN CONNECTIONS THIS SIDE

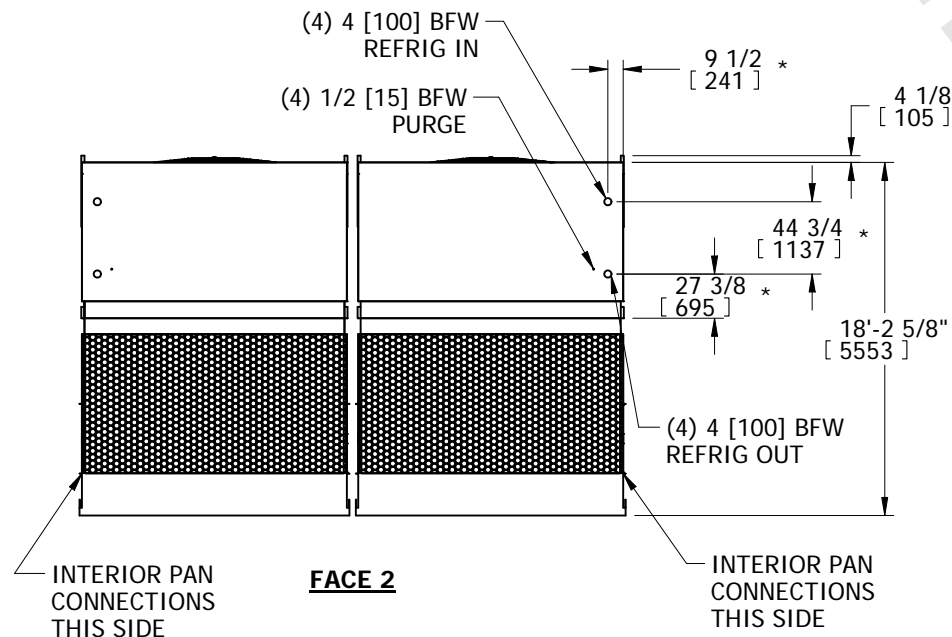

FACE 2

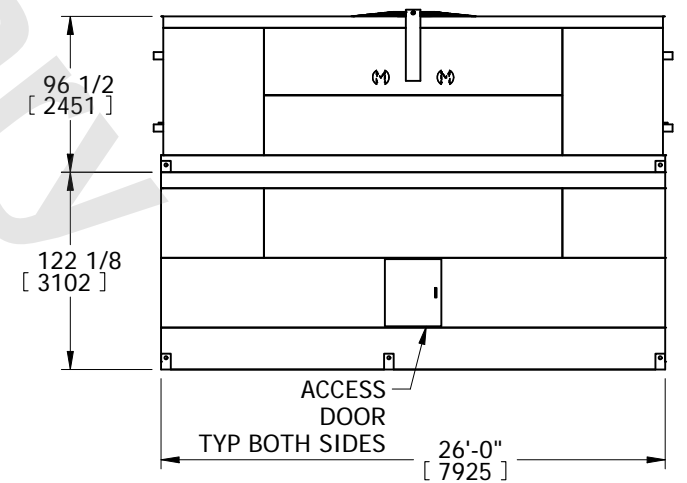

FACE 1

SHIPPING WEIGHT 66320 lbs+ [30085] kg+	OPERATING WEIGHT 107440 lbs+ [48735] kg+	HEAVIEST SECTION WEIGHT 21660 lbs+ [9825] kg+	NO. OF SHIPPING SECTIONS 4	DRAWN BY: TLS
---	---	--	-------------------------------	------------------