

CONFIDENTIAL  
 This document is the property of Evapco, Inc. It should not be copied or disclosed without prior written authorization.

EVAPCO, INC.

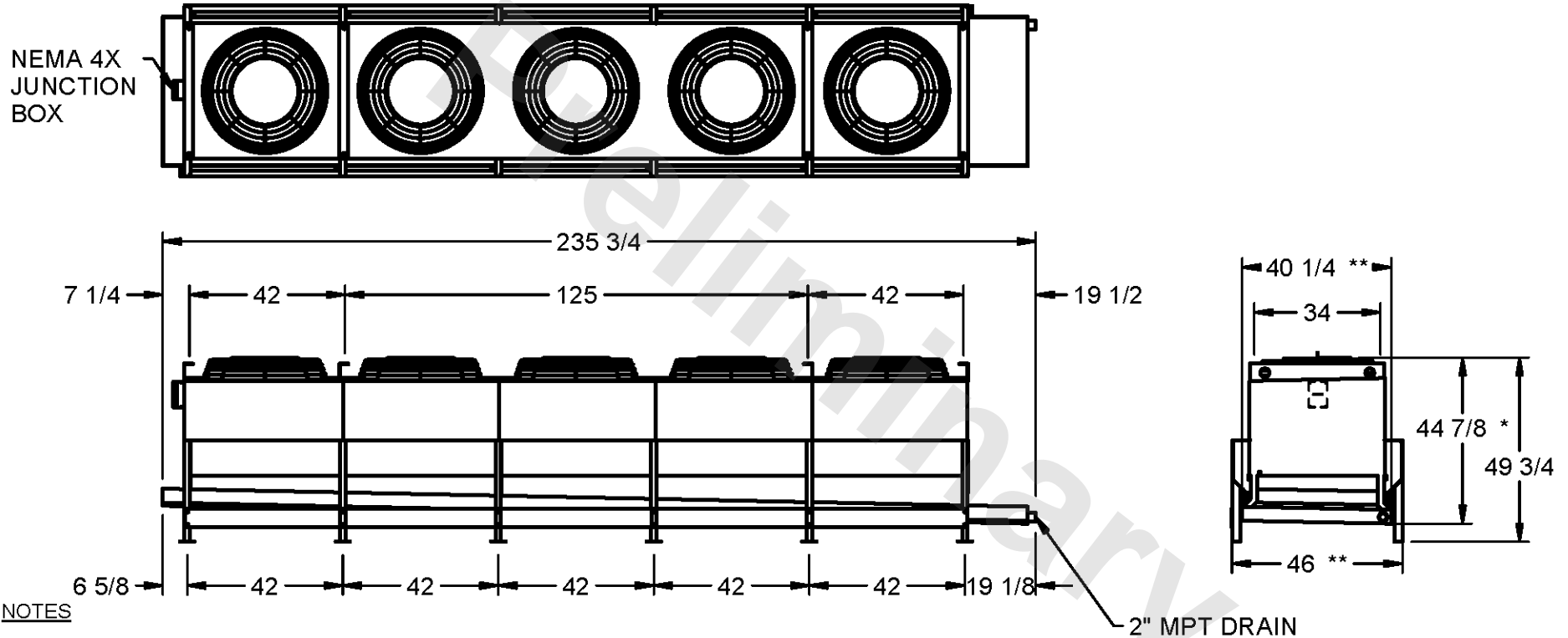

CUSTOMER \_\_\_\_\_ MODEL # SSTWB5-47S86E0075F1LA SCALE N.T.S. DWG.# STWA5-SE REV. 0 DATE 4/24/2026



NOTES

- 1) ALL DIMENSIONS ARE FOR REFERENCE AND SHOULD NOT BE USED FOR PREFABRICATION OF PIPING OR SUPPORTS.
- 2) HANGER HOLES ARE FOR 3/4 INCH THREADED ROD.
- \* HOT GAS DEFROST ADDS 1/2 INCH TO THE HEIGHT OF A STANDARD UNIT, WATER DEFROST ADDS 6 INCHES TO THE HEIGHT OF A STANDARD UNIT AND CHANGES THE DRAIN SIZE
- \* TWO ROWS REHEAT ADDS 5.25 INCHES TO THE HEIGHT OF 6 AND 8 ROW DEEEP STANDARD UNITS.
- \* FOUR ROWS REHEAT ADDS 5.25 INCHES TO THE HEIGHT OF 4 AND 6 ROW DEEP STANDARD UNITS AND 8.75 INCHES TO THE HEIGHT OF 8 ROW DEEP STANDARD UNITS.
- \*\* EXTENDED WIDTH DRAIN PAN ADDS 6 INCHES TO THE WIDTH OF A STANDARD UNIT.

PROJECT \_\_\_\_\_ ROOM \_\_\_\_\_ SHIPPING WEIGHT 2730 lbs+ [1240] kg+ OPERATING WEIGHT 3440 lbs+ [1565] kg+