

CONFIDENTIAL

This document is the property of Evapco, Inc. It should not be copied or disclosed without prior written authorization.

EVAPCO, INC.



CUSTOMER _____ MODEL # SSTWB2-19R43F0100F1LA SCALE N.T.S. DWG.# STWA2-SE-4L REV. 0 DATE 6/25/2026

NEMA 4X
JUNCTION
BOX

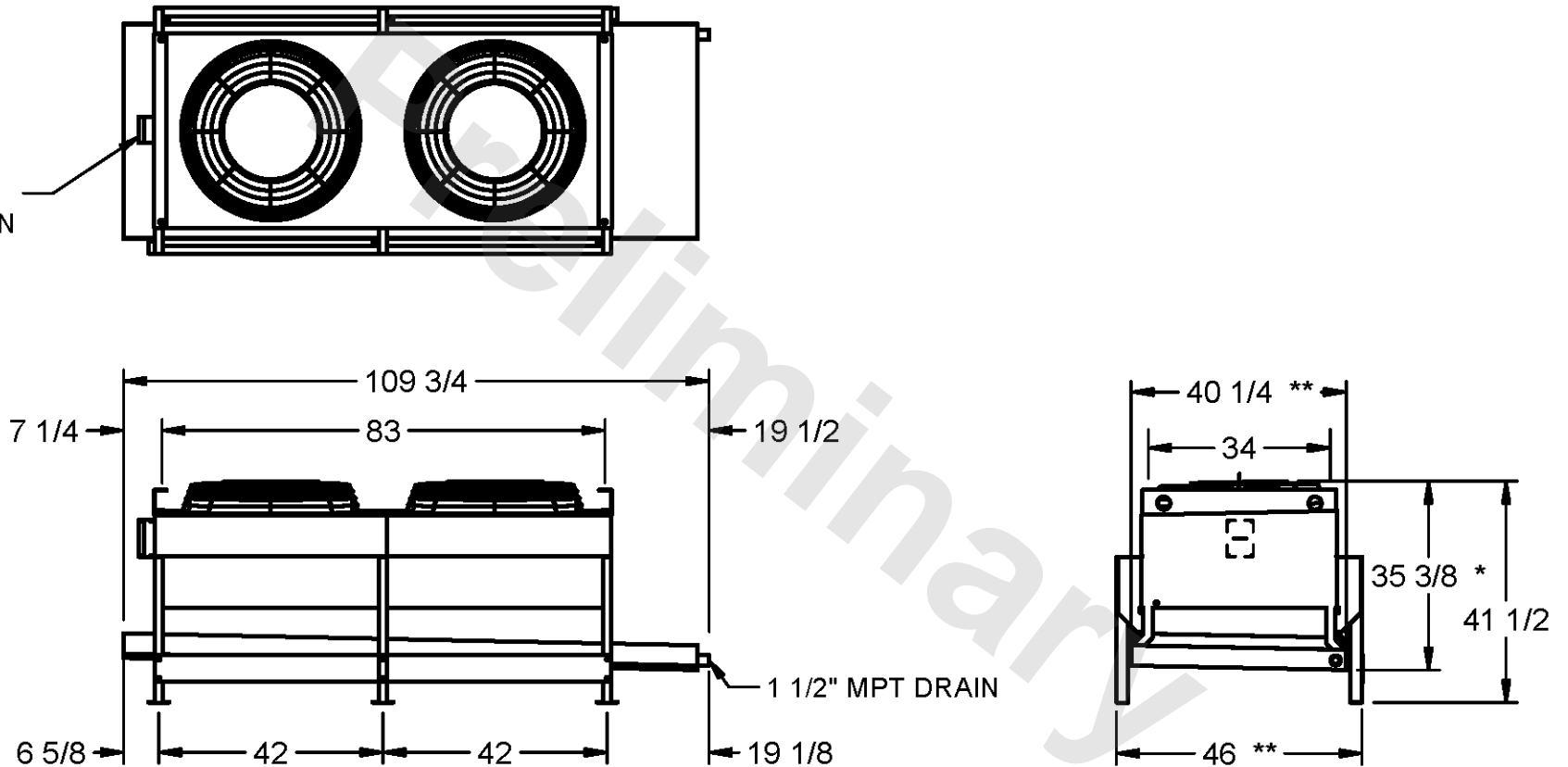

NOTES

- 1) ALL DIMENSIONS ARE FOR REFERENCE AND SHOULD NOT BE USED FOR PREFABRICATION OF PIPING OR SUPPORTS.
- 2) HANGER HOLES ARE FOR 3/4 INCH THREADED ROD.
- * HOT GAS DEFROST ADDS 1/2 INCH TO THE HEIGHT OF A STANDARD UNIT, WATER DEFROST ADDS 6 INCHES TO THE HEIGHT OF A STANDARD UNIT AND CHANGES THE DRAIN SIZE.
- ** EXTENDED WIDTH DRAIN PAN ADDS 6 INCHES TO THE WIDTH OF A STANDARD UNIT.

PROJECT _____ ROOM _____ SHIPPING WEIGHT 850 lbs+ [390] kg+ OPERATING WEIGHT 930 lbs+ [425] kg+