

UNIT	CONDENSER	
MODEL #	eco-ATC-2410A	SCALE NTS



DWG. #	WB3242412-DRD-ST	REV.	-
SERIAL #		DATE	5/5/2026

- NOTES:
- (M)- FAN MOTOR LOCATION
  - HEAVIEST SECTION IS UPPER SECTION
  - MPT DENOTES MALE PIPE THREAD  
FPT DENOTES FEMALE PIPE THREAD  
BFW DENOTES BEVELED FOR WELDING  
GVD DENOTES GROOVED  
FLG DENOTES FLANGE  
PE DENOTES PLAIN END
  - +UNIT WEIGHT DOES NOT INCLUDE ACCESSORIES (SEE ACCESSORY DRAWINGS)
  - MAKE-UP WATER PRESSURE  
20 psi MIN [137 kPa], 50 psi MAX [344 kPa]
  - \*-APPROXIMATE DIMENSIONS DO NOT USE FOR PRE-FABRICATION OF CONNECTING PIPING
  - 3/4" [19mm] DIA. MOUNTING HOLES. REFER TO RECOMMENDED STEEL SUPPORT DRAWING.
  - DIMENSIONS LISTED AS FOLLOWS:  
ENGLISH FT-IN  
METRIC [mm]

**FACE B**  
**PLAN VIEW**

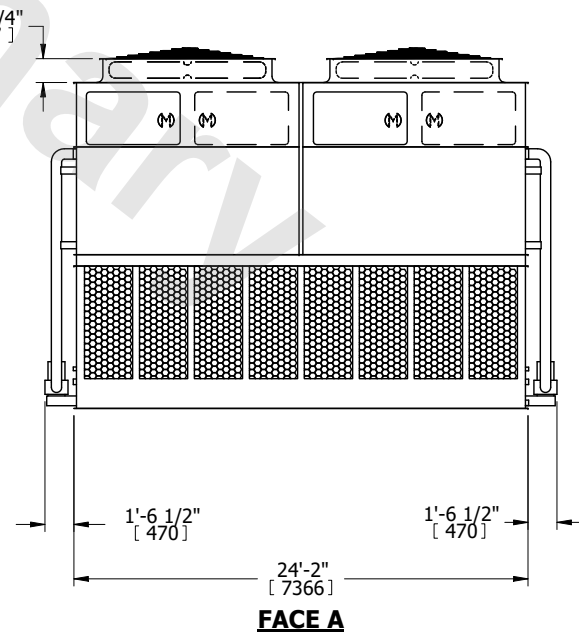
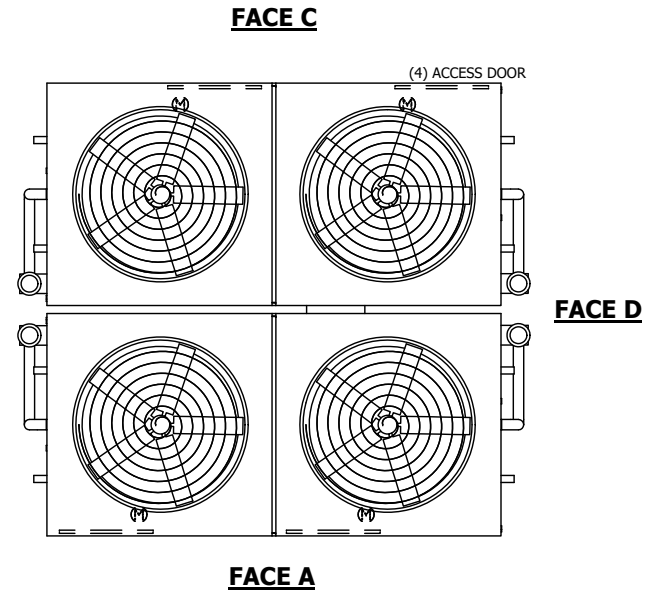

SHIPPING WEIGHT	106420 lbs+ [48275] kg+	OPERATING WEIGHT	135080 lbs+ [61275] kg+	HEAVIEST SECTION WEIGHT	23810 lbs+ [10805] kg+	NO. OF SHIPPING SECTIONS	6	DRAWN BY:	SLR
-----------------	-------------------------	------------------	-------------------------	-------------------------	------------------------	--------------------------	---	-----------	-----