

CONFIDENTIAL

This document is the property of Evapco, Inc. It should not be copied or disclosed without prior written authorization.

EVAPCO, INC.



CUSTOMER

MODEL #
SSTHB4-13412VE0750K1LA

SCALE
N.T.S.

DWG. #
STL4-SE-24-10R-FL

REV. 1

DATE
6/25/2026

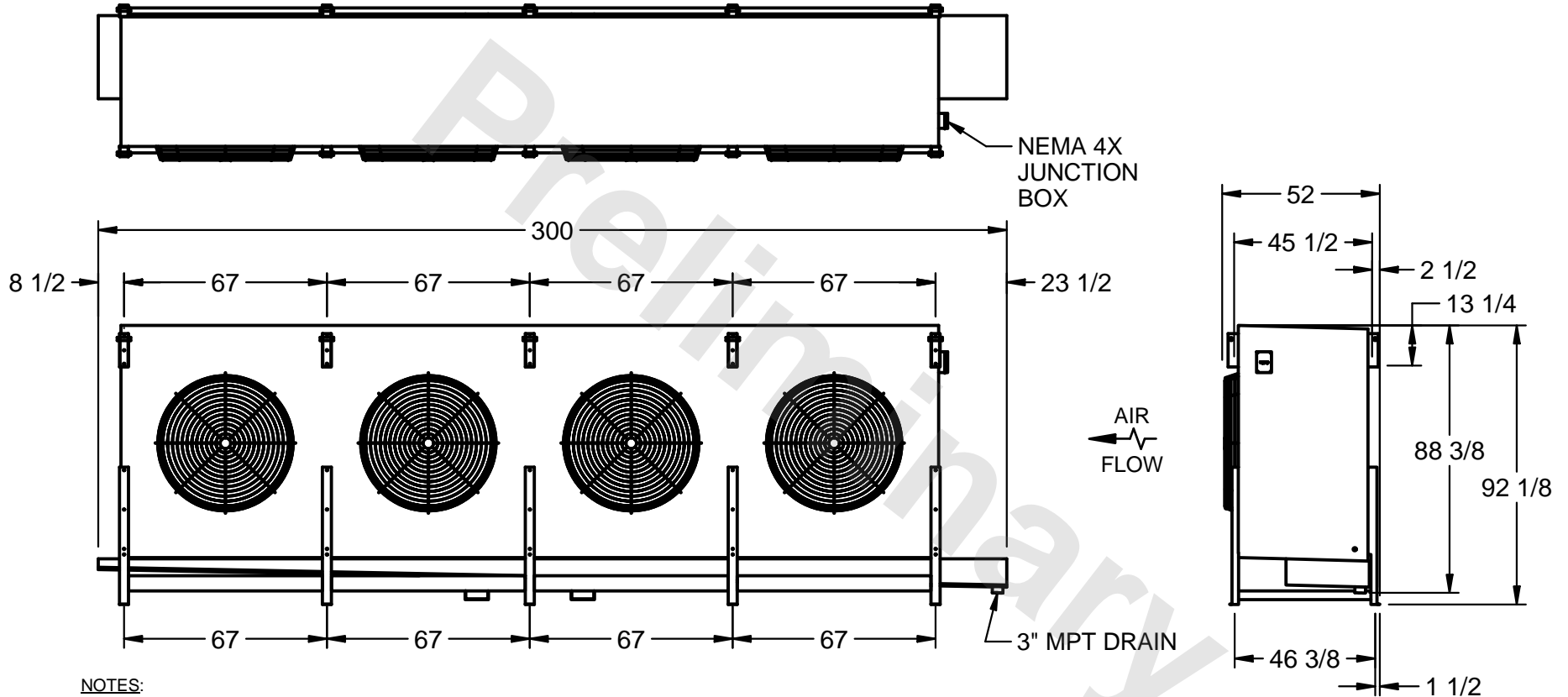

NOTES:

- 1) RIGHT HAND MODEL SHOWN.
- 2) ALL DIMENSIONS ARE FOR REFERENCE AND SHOULD NOT BE USED FOR PREFABRICATION OF PIPING OR SUPPORTS.
- 3) WATER DEFROST ADDS 6 INCHES TO HEIGHT OF STANDARD UNIT AND CHANGES DRAIN SIZE.
- 4) HANGER HOLES ARE FOR 3/4 INCH THREADED ROD.

PROJECT

ROOM

SHIPPING WEIGHT 7940 lbs

OPERATING WEIGHT 9740 lbs