

UNIT CLOSED CIRCUIT COOLER	SCALE NTS
MODEL # ESW4 14-43N22-LP	

EVAPCO, INC.

DWG. # WX414224806-DRB-ST	REV -
SERIAL #	DATE: 4/28/2026

- NOTES:
- (M)- FAN MOTOR LOCATION
 - HEAVIEST SECTION IS COIL SECTION
 - MPT DENOTES MALE PIPE THREAD
FPT DENOTES FEMALE PIPE THREAD
BFW DENOTES BEVELED FOR WELDING
GVD DENOTES GROOVED
FLG DENOTES FLANGE
 - +UNIT WEIGHT DOES NOT INCLUDE ACCESSORIES (SEE ACCESSORY DRAWINGS)
 - 3/4" [19MM] DIA. MOUNTING HOLES. REFER TO RECOMMENDED STEEL SUPPORT DRAWING
 - MAKE-UP WATER PRESSURE
20 psi MIN [137 kPa], 50 psi MAX [344 kPa]
 - DIMENSIONS LISTED AS FOLLOWS:
ENGLISH FT-IN
[METRIC] [mm]
 - * - APPROXIMATE DIMENSIONS DO NOT USE FOR PRE-FABRICATION OF CONNECTING PIPING

**FACE B
PLAN VIEW**



FACE A



FACE A

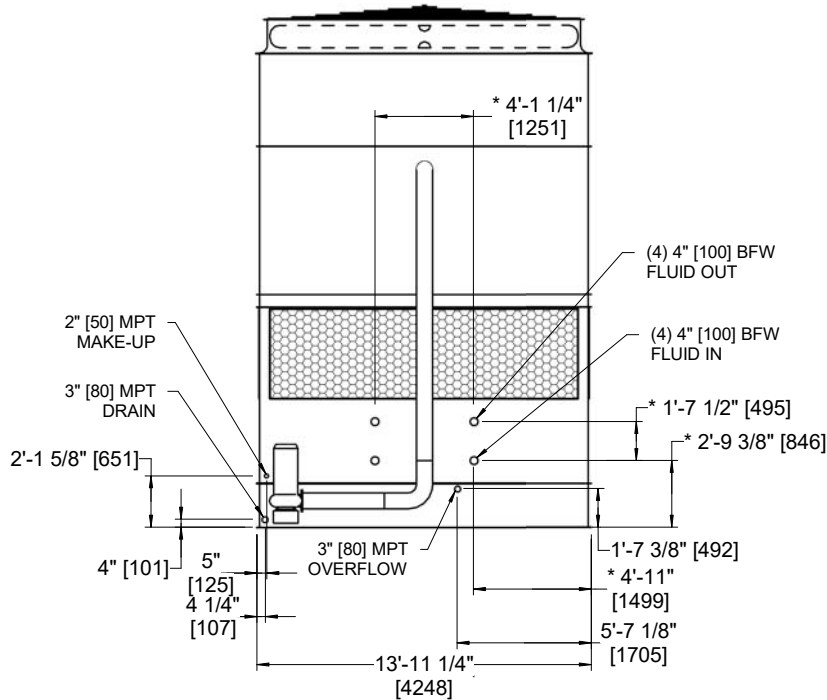

FACE B

MODEL NUMBER	DIMENSION A
ESW4 14-43*22-LP	2'-1 3/4"
ESW4 14-43*22-AP	2'-7 1/4"

SHIPPING WEIGHT 36640 lbs+ [16620] kg+	OPERATING WEIGHT 54500 lbs+ [24725] kg+	HEAVIEST SECTION WEIGHT 23240 lbs+ [10545] kg+	NO. OF SHIPPING SECTIONS 2	DRAWN BY: JLG
---	--	---	-------------------------------	------------------