

UNIT	CLOSED CIRCUIT COOLER
MODEL #	ESW4 14-45N22-LP
SCALE	NTS

EVAPCO, INC.

DWG. #	WX414224810-DRB-ST	REV	-
SERIAL #		DATE:	7/7/2026

- NOTES:
- (M)- FAN MOTOR LOCATION
 - HEAVIEST SECTION IS COIL SECTION
 - MPT DENOTES MALE PIPE THREAD
FPT DENOTES FEMALE PIPE THREAD
BFW DENOTES BEVELED FOR WELDING
GVD DENOTES GROOVED
FLG DENOTES FLANGE
 - +UNIT WEIGHT DOES NOT INCLUDE ACCESSORIES (SEE ACCESSORY DRAWINGS)
 - 3/4" [19MM] DIA. MOUNTING HOLES. REFER TO RECOMMENDED STEEL SUPPORT DRAWING
 - MAKE-UP WATER PRESSURE
20 psi MIN [137 kPa], 50 psi MAX [344 kPa]
 - DIMENSIONS LISTED AS FOLLOWS:
ENGLISH FT-IN
[METRIC] [mm]
 - * - APPROXIMATE DIMENSIONS DO NOT USE FOR PRE-FABRICATION OF CONNECTING PIPING

**FACE B
PLAN VIEW**

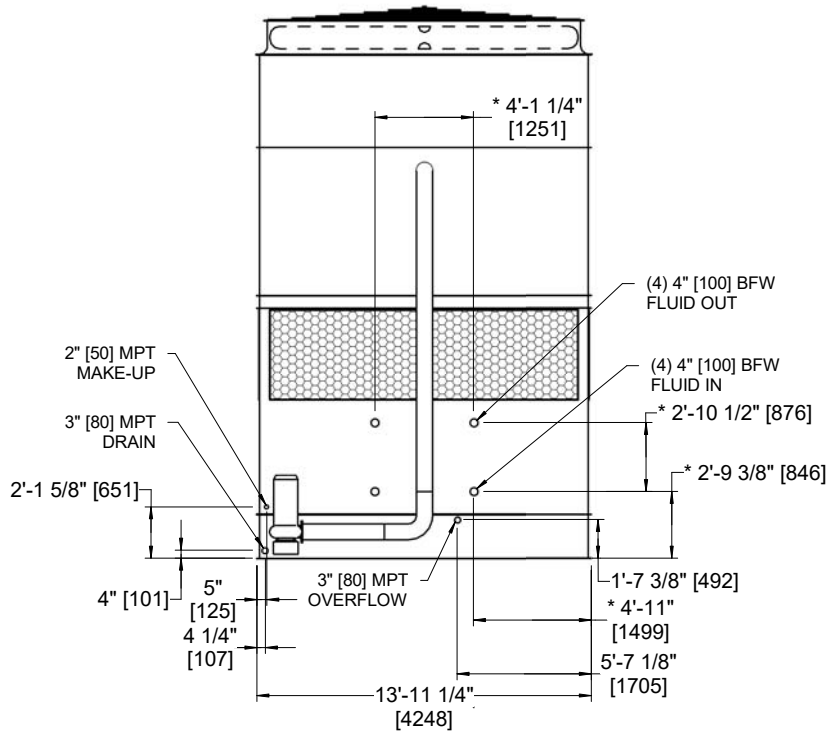
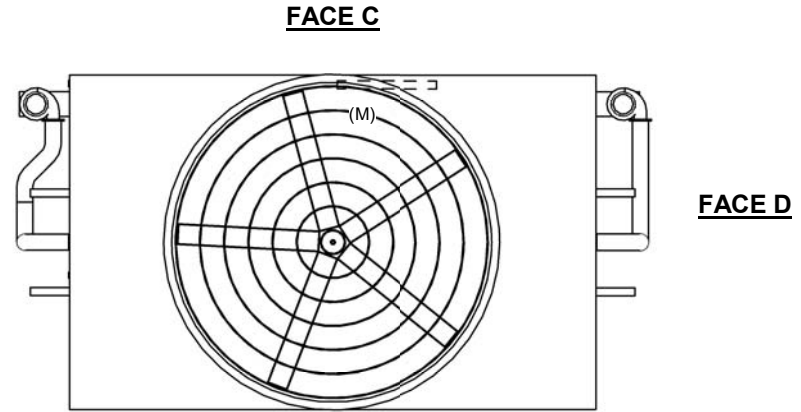

FACE B



FACE A

MODEL NUMBER	DIMENSION A
ESW4 14-45*22-LP	2'-1 3/4"
ESW4 14-45*22-AP	2'-7 1/4"

SHIPPING WEIGHT 44060 lbs+ [19990] kg+

OPERATING WEIGHT 64680 lbs+ [29340] kg+

HEAVIEST SECTION WEIGHT 30660 lbs+ [13910] kg+

NO. OF SHIPPING SECTIONS 2

DRAWN BY: JLG