

UNIT	CLOSED CIRCUIT COOLER
MODEL #	ESW4 12-42N12-SP
SCALE	NTS

EVAPCO, INC.



DWG. #	WX412124804P-DRA-ST	REV	-
SERIAL #		DATE:	7/5/2026

NOTES:

- (M)- FAN MOTOR LOCATION
- HEAVIEST SECTION IS COIL SECTION
- MPT DENOTES MALE PIPE THREAD
FPT DENOTES FEMALE PIPE THREAD
BFW DENOTES BEVELED FOR WELDING
GVD DENOTES GROOVED
FLG DENOTES FLANGE
- +UNIT WEIGHT DOES NOT INCLUDE ACCESSORIES (SEE ACCESSORY DRAWINGS)
- 3/4" [19MM] DIA. MOUNTING HOLES. REFER TO RECOMMENDED STEEL SUPPORT DRAWING
- MAKE-UP WATER PRESSURE
20 psi MIN [137 kPa], 50 psi MAX [344 kPa]
- DIMENSIONS LISTED AS FOLLOWS:
ENGLISH FT-IN
[METRIC] [mm]
- * - APPROXIMATE DIMENSIONS DO NOT USE FOR PRE-FABRICATION OF CONNECTING PIPING

**FACE B
PLAN VIEW**



FACE A

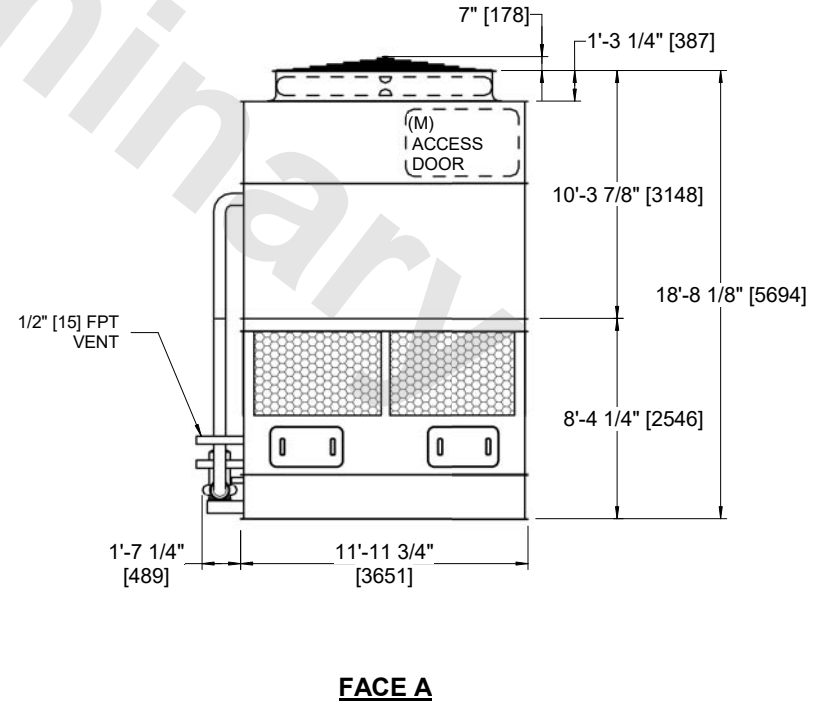
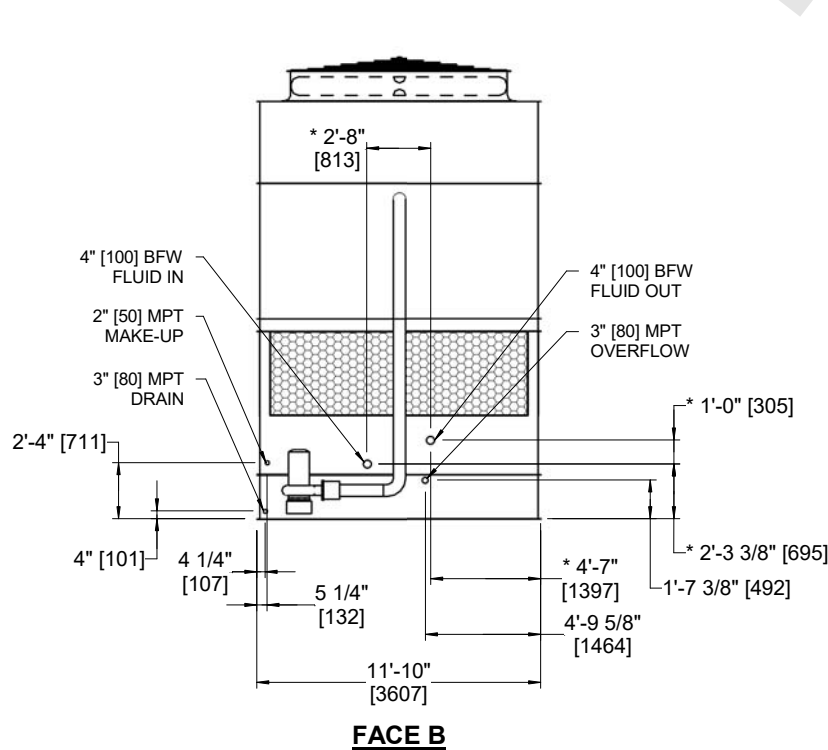

SHIPPING WEIGHT	14600 lbs+ [6625] kg+	OPERATING WEIGHT	21820 lbs+ [9900] kg+	HEAVIEST SECTION WEIGHT	8130 lbs+ [3690] kg+	NO. OF SHIPPING SECTIONS	2	DRAWN BY:	AWT
-----------------	-----------------------	------------------	-----------------------	-------------------------	----------------------	--------------------------	---	-----------	-----