

UNIT	CLOSED CIRCUIT COOLER
MODEL #	ESW4 12-46M18-LF
SCALE	NTS

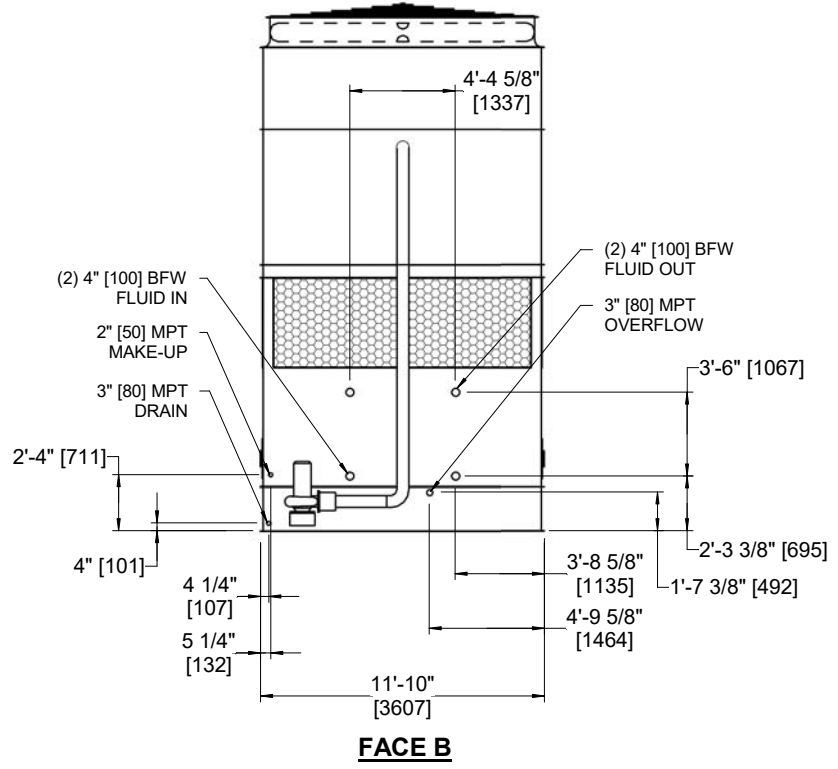

DWG. #	WX412184812F-DRA-ST	REV	-
SERIAL #		DATE:	5/19/2026

- NOTES:
- (M)- FAN MOTOR LOCATION
  - HEAVIEST SECTION IS COIL SECTION
  - MPT DENOTES MALE PIPE THREAD  
FPT DENOTES FEMALE PIPE THREAD  
BFW DENOTES BEVELED FOR WELDING  
GVD DENOTES GROOVED  
FLG DENOTES FLANGE
  - +UNIT WEIGHT DOES NOT INCLUDE ACCESSORIES (SEE ACCESSORY DRAWINGS)
  - 3/4" [19MM] DIA. MOUNTING HOLES. REFER TO RECOMMENDED STEEL SUPPORT DRAWING
  - MAKE-UP WATER PRESSURE  
20 psi MIN [137 kPa], 50 psi MAX [344 kPa]
  - DIMENSIONS LISTED AS FOLLOWS:  
ENGLISH FT-IN  
[METRIC] [mm]
  - \* - APPROXIMATE DIMENSIONS DO NOT USE FOR PRE-FABRICATION OF CONNECTING PIPING



SHIPPING WEIGHT	36510 lbs+ [16565] kg+	OPERATING WEIGHT	53080 lbs+ [24080] kg+	HEAVIEST SECTION WEIGHT	28200 lbs+ [12795] kg+	NO. OF SHIPPING SECTIONS	2	DRAWN BY:	AWT
-----------------	------------------------	------------------	------------------------	-------------------------	------------------------	--------------------------	---	-----------	-----