

UNIT	CLOSED CIRCUIT COOLER
MODEL #	ESW4 12-45P18-LF
SCALE	NTS

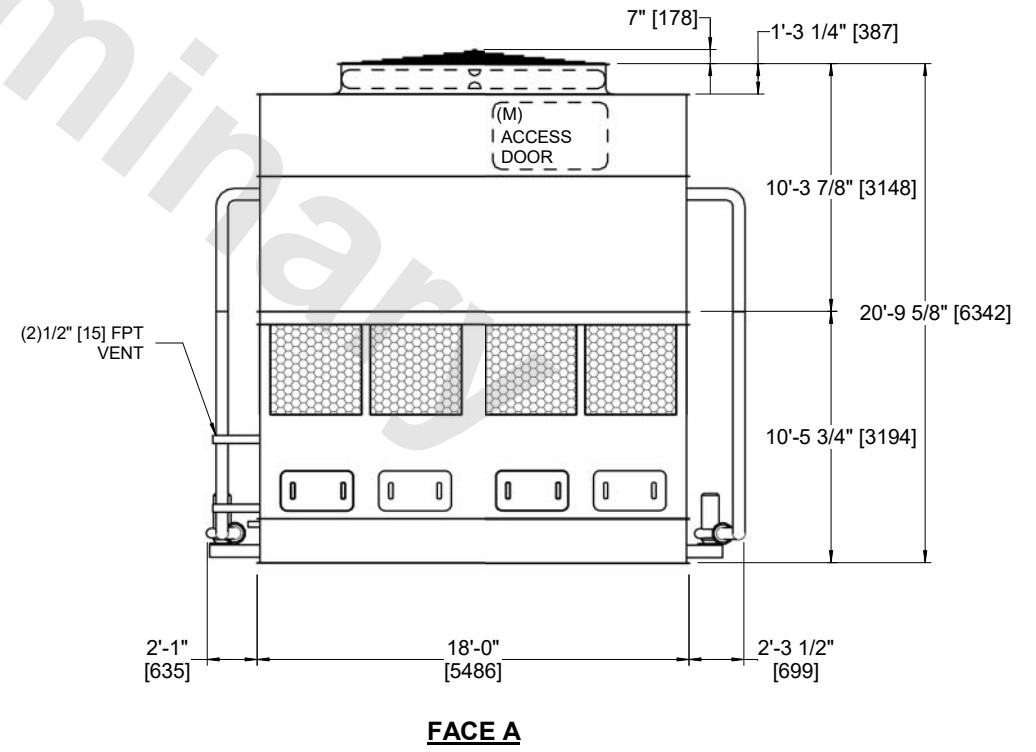

DWG. #	WX412184810F-DRA-ST	REV	-
SERIAL #		DATE:	7/8/2026

- NOTES:
1. (M)- FAN MOTOR LOCATION
 2. HEAVIEST SECTION IS COIL SECTION
 3. MPT DENOTES MALE PIPE THREAD
FPT DENOTES FEMALE PIPE THREAD
BFW DENOTES BEVELED FOR WELDING
GVD DENOTES GROOVED
FLG DENOTES FLANGE
 4. +UNIT WEIGHT DOES NOT INCLUDE ACCESSORIES (SEE ACCESSORY DRAWINGS)
 5. 3/4" [19MM] DIA. MOUNTING HOLES. REFER TO RECOMMENDED STEEL SUPPORT DRAWING
 6. MAKE-UP WATER PRESSURE
20 psi MIN [137 kPa], 50 psi MAX [344 kPa]
 7. DIMENSIONS LISTED AS FOLLOWS:
ENGLISH FT-IN
[METRIC] [mm]
 8. * - APPROXIMATE DIMENSIONS DO NOT USE FOR PRE-FABRICATION OF CONNECTING PIPING



SHIPPING WEIGHT	33730 lbs+ [15300] kg+	OPERATING WEIGHT	49090 lbs+ [22270] kg+	HEAVIEST SECTION WEIGHT	24990 lbs+ [11340] kg+	NO. OF SHIPPING SECTIONS	2	DRAWN BY:	AWT
-----------------	------------------------	------------------	------------------------	-------------------------	------------------------	--------------------------	---	-----------	-----