

UNIT	CLOSED CIRCUIT COOLER
MODEL #	ESW4 12-35K18-LF
SCALE	NTS

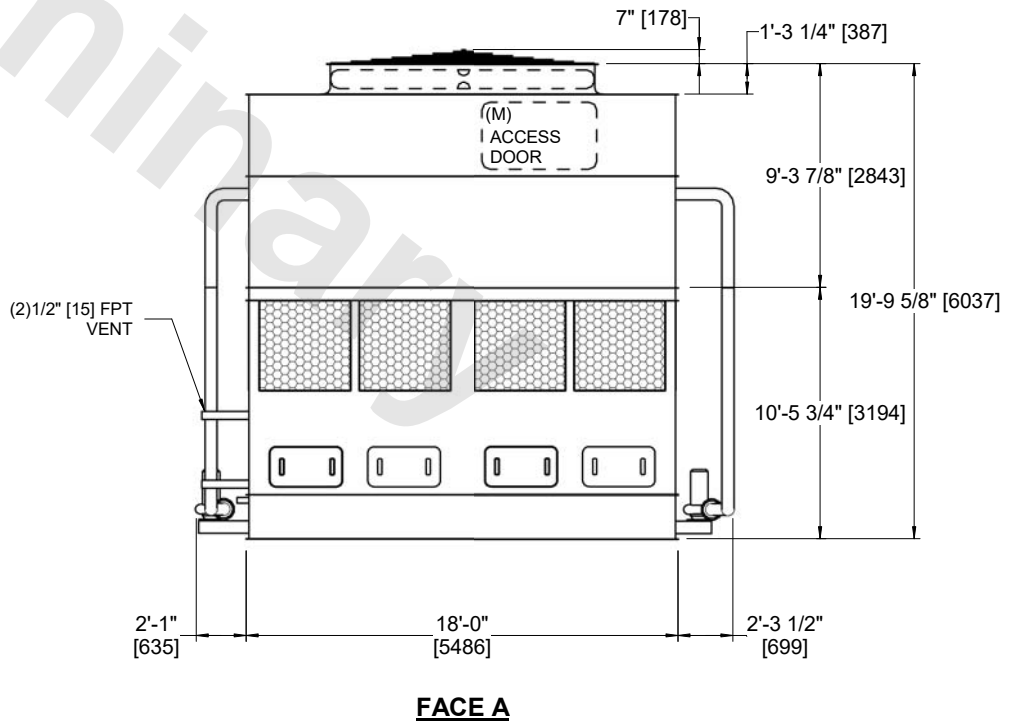

DWG. #	WX412183610F-DRA-ST	REV	-
SERIAL #		DATE:	5/9/2026

- NOTES:
1. (M)- FAN MOTOR LOCATION
  2. HEAVIEST SECTION IS COIL SECTION
  3. MPT DENOTES MALE PIPE THREAD  
FPT DENOTES FEMALE PIPE THREAD  
BFW DENOTES BEVELED FOR WELDING  
GVD DENOTES GROOVED  
FLG DENOTES FLANGE
  4. +UNIT WEIGHT DOES NOT INCLUDE ACCESSORIES (SEE ACCESSORY DRAWINGS)
  5. 3/4" [19MM] DIA. MOUNTING HOLES. REFER TO RECOMMENDED STEEL SUPPORT DRAWING
  6. MAKE-UP WATER PRESSURE  
20 psi MIN [137 kPa], 50 psi MAX [344 kPa]
  7. DIMENSIONS LISTED AS FOLLOWS:  
ENGLISH FT-IN  
[METRIC] [mm]
  8. \* - APPROXIMATE DIMENSIONS DO NOT USE FOR PRE-FABRICATION OF CONNECTING PIPING

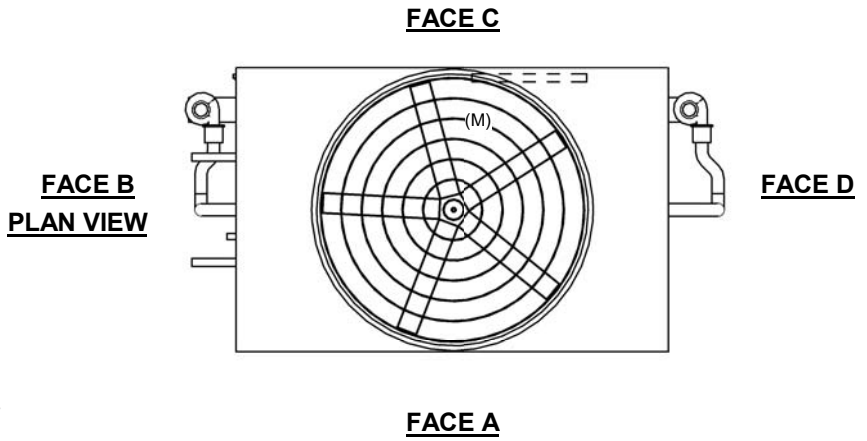

SHIPPING WEIGHT	32440 lbs+ [14715] kg+	OPERATING WEIGHT	47800 lbs+ [21685] kg+	HEAVIEST SECTION WEIGHT	24990 lbs+ [11340] kg+	NO. OF SHIPPING SECTIONS	2	DRAWN BY:	AWT
-----------------	------------------------	------------------	------------------------	-------------------------	------------------------	--------------------------	---	-----------	-----