

UNIT	CLOSED CIRCUIT COOLER
MODEL #	ESW4 12-45K12-SF
SCALE	NTS

# EVAPCO, INC.



DWG. #	WX412124810F-DRA-ST	REV	-
SERIAL #		DATE:	7/7/2026

**NOTES:**

- (M)- FAN MOTOR LOCATION
- HEAVIEST SECTION IS COIL SECTION
- MPT DENOTES MALE PIPE THREAD  
FPT DENOTES FEMALE PIPE THREAD  
BFW DENOTES BEVELED FOR WELDING  
GVD DENOTES GROOVED  
FLG DENOTES FLANGE
- +UNIT WEIGHT DOES NOT INCLUDE ACCESSORIES (SEE ACCESSORY DRAWINGS)
- 3/4" [19MM] DIA. MOUNTING HOLES. REFER TO RECOMMENDED STEEL SUPPORT DRAWING
- MAKE-UP WATER PRESSURE  
20 psi MIN [137 kPa], 50 psi MAX [344 kPa]
- DIMENSIONS LISTED AS FOLLOWS:  
ENGLISH FT-IN  
[METRIC] [mm]
- \* - APPROXIMATE DIMENSIONS DO NOT USE FOR PRE-FABRICATION OF CONNECTING PIPING

**FACE B  
PLAN VIEW**

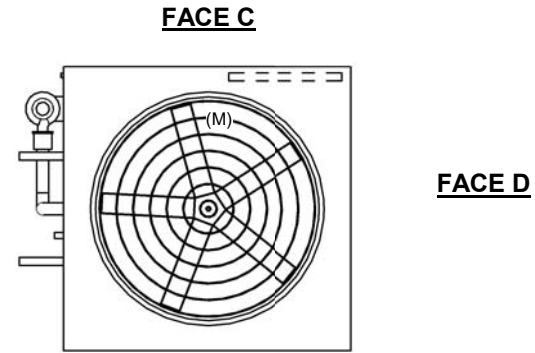

**FACE A**

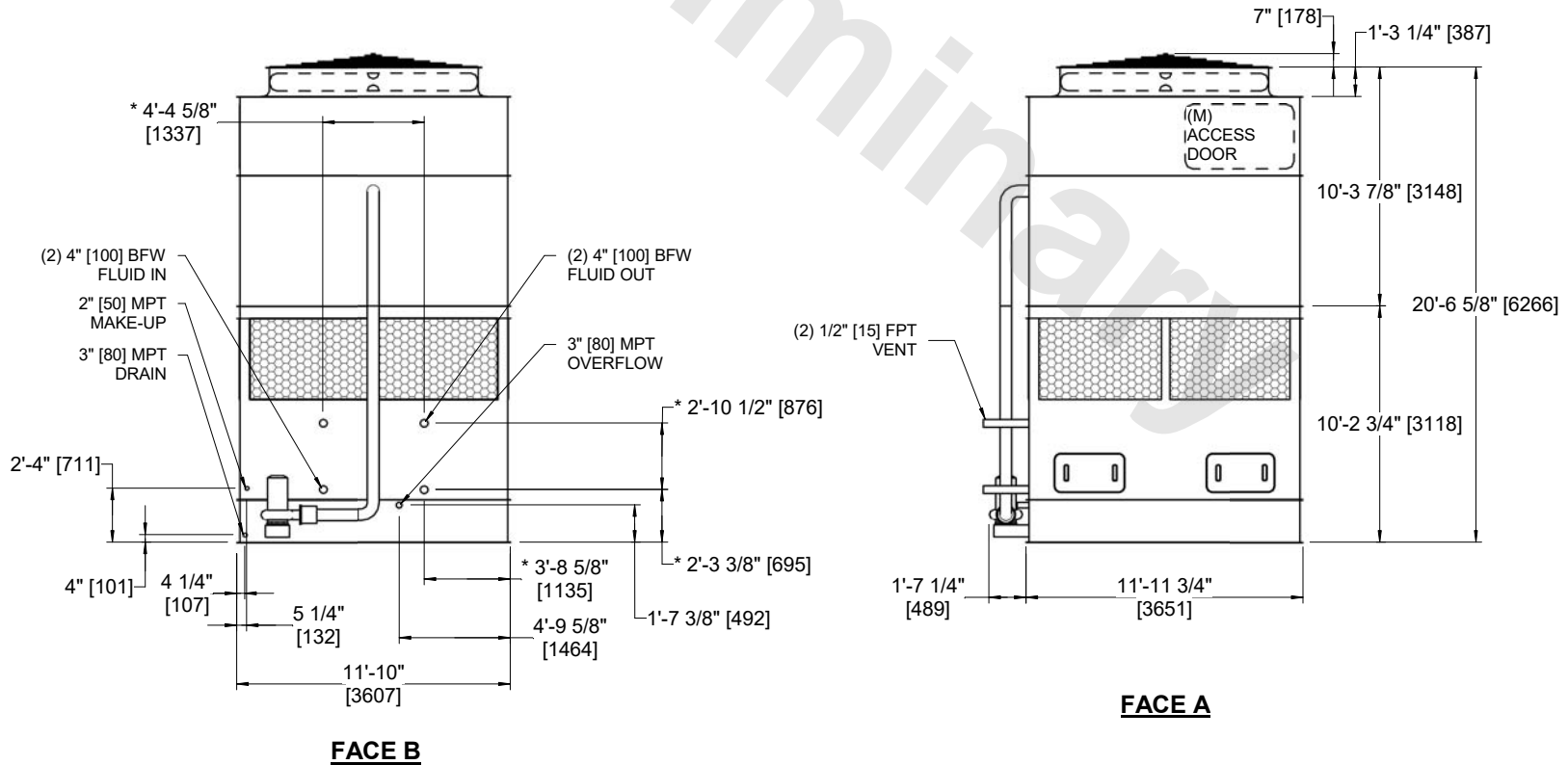

**FACE B**

SHIPPING WEIGHT	22270 lbs+ [10105] kg+	OPERATING WEIGHT	32430 lbs+ [14715] kg+	HEAVIEST SECTION WEIGHT	16200 lbs+ [7350] kg+	NO. OF SHIPPING SECTIONS	2	DRAWN BY:	AWT
-----------------	------------------------	------------------	------------------------	-------------------------	-----------------------	--------------------------	---	-----------	-----