

|         |               |           |
|---------|---------------|-----------|
| UNIT    | COOLING TOWER |           |
| MODEL # | AT 17-4H14    | SCALE NTS |

# EVAPCO, INC.

|          |                   |       |           |
|----------|-------------------|-------|-----------|
| DWG. #   | CT4C071448-DRA-ST | REV   | -         |
| SERIAL # |                   | DATE: | 4/28/2026 |

**NOTES:**

1. (M)- FAN MOTOR LOCATION
2. HEAVIEST SECTION IS FAN/CASING SECTION
3. MPT DENOTES MALE PIPE THREAD  
FPT DENOTES FEMALE PIPE THREAD  
BFW DENOTES BEVELED FOR WELDING  
GVD DENOTES GROOVED  
FLG DENOTES FLANGE
4. +UNIT WEIGHT DOES NOT INCLUDE ACCESSORIES (SEE ACCESSORY DRAWINGS)
5. 3/4" [19MM] DIA. MOUNTING HOLES. REFER TO RECOMMENDED STEEL SUPPORT DRAWING
6. DIMENSIONS LISTED AS FOLLOWS:  
ENGLISH FT-IN  
[METRIC] [mm]
7. MAKE-UP WATER PRESSURE  
20 psi MIN [137 kPa], 50 psi MAX [344 kPa]

**FACE C**

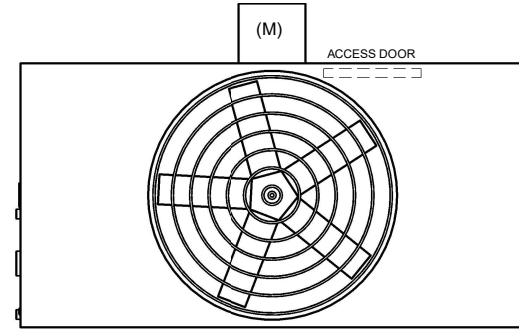

**FACE D**

**FACE B  
PLAN VIEW**

**FACE A**

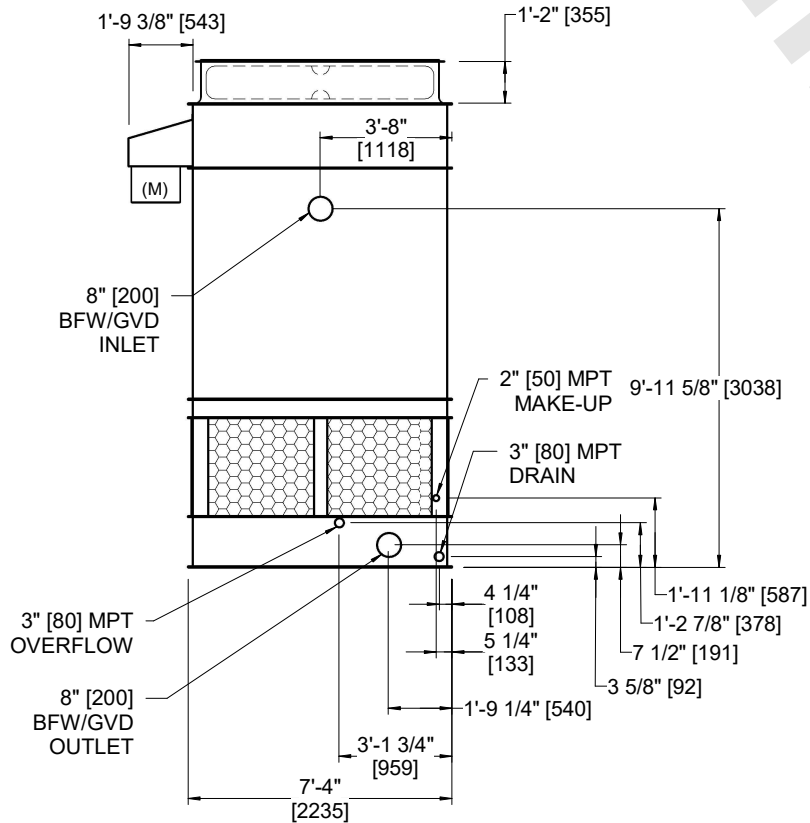

**FACE B**

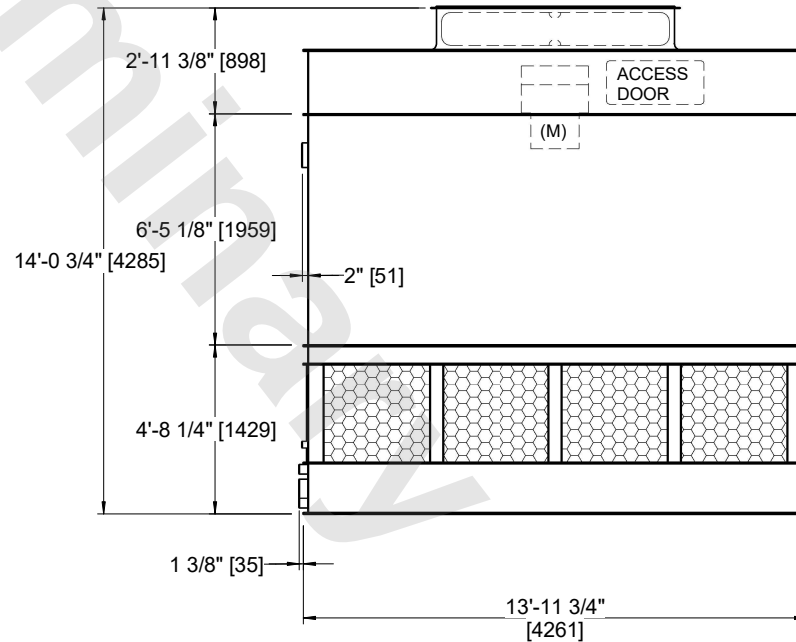

**FACE A**

|                 |                      |                  |                      |                         |                      |                          |   |           |     |
|-----------------|----------------------|------------------|----------------------|-------------------------|----------------------|--------------------------|---|-----------|-----|
| SHIPPING WEIGHT | 6030 lbs+ [2740] kg+ | OPERATING WEIGHT | 9960 lbs+ [4520] kg+ | HEAVIEST SECTION WEIGHT | 4130 lbs+ [1875] kg+ | NO. OF SHIPPING SECTIONS | 2 | DRAWN BY: | JLG |
|-----------------|----------------------|------------------|----------------------|-------------------------|----------------------|--------------------------|---|-----------|-----|