

UNIT	COOLING TOWER	
MODEL #	AT 110-4K18	SCALE NTS

EVAPCO, INC.

DWG. #	T3TM1848-DRD-ST	REV.	-
SERIAL #		DATE	6/25/2026

- NOTES:
- (M)- FAN MOTOR LOCATION
 - HEAVIEST SECTION IS UPPER SECTION
 - MPT DENOTES MALE PIPE THREAD
FPT DENOTES FEMALE PIPE THREAD
BFW DENOTES BEVELED FOR WELDING
GVD DENOTES GROOVED
FLG DENOTES FLANGE
 - +UNIT WEIGHT DOES NOT INCLUDE ACCESSORIES (SEE ACCESSORY DRAWINGS)
MAKE-UP WATER PRESSURE
20 psi MIN [137 kPa], 50 psi MAX [344 kPa]
 - 3/4" [19MM] DIA. MOUNTING HOLES.
REFER TO RECOMMENDED STEEL SUPPORT DRAWING
 - DIMENSIONS LISTED AS FOLLOWS:
ENGLISH FT-IN
[METRIC] [mm]

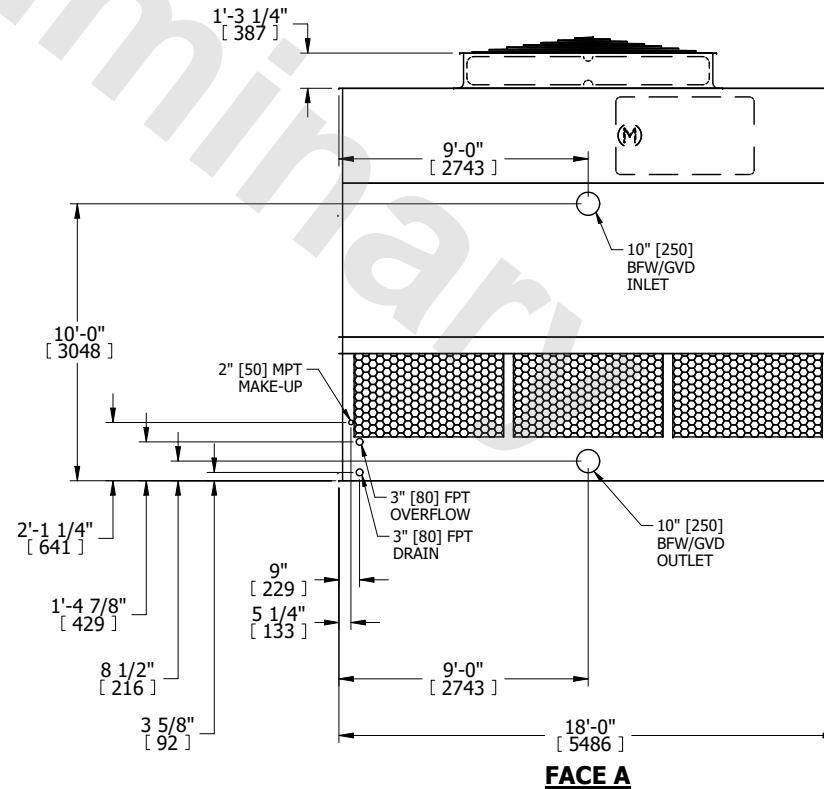
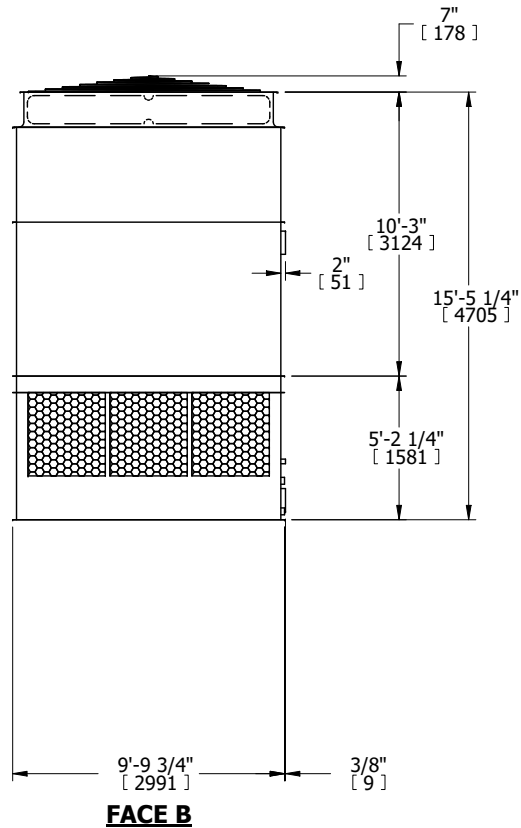

SHIPPING WEIGHT	10630 lbs+ [4825] kg+	OPERATING WEIGHT	18230 lbs+ [8270] kg+	HEAVIEST SECTION WEIGHT	7080 lbs+ [3215] kg+	NO. OF SHIPPING SECTIONS	2	DRAWN BY:	KDS
-----------------	-----------------------	------------------	-----------------------	-------------------------	----------------------	--------------------------	---	-----------	-----