

UNIT	COOLING TOWER	
MODEL #	AT 114-3024	SCALE NTS

EVAPCO, INC.

DWG. #	T4142436-DRA-ST	REV.	-
SERIAL #		DATE	6/27/2026

- NOTES:
- (M)- FAN MOTOR LOCATION
 - HEAVIEST SECTION IS UPPER SECTION
 - MPT DENOTES MALE PIPE THREAD
FPT DENOTES FEMALE PIPE THREAD
BFW DENOTES BEVELED FOR WELDING
GVD DENOTES GROOVED
FLG DENOTES FLANGE
PE DENOTES PLAIN END
 - +UNIT WEIGHT DOES NOT INCLUDE ACCESSORIES (SEE ACCESSORY DRAWINGS)
 - MAKE-UP WATER PRESSURE
20 psi MIN [137 kPa], 50 psi MAX [344 kPa]
 - 3/4" [19MM] DIA. MOUNTING HOLES.
REFER TO RECOMMENDED STEEL SUPPORT DRAWING
 - DIMENSIONS LISTED AS FOLLOWS:
ENGLISH FT-IN
[METRIC] [mm]

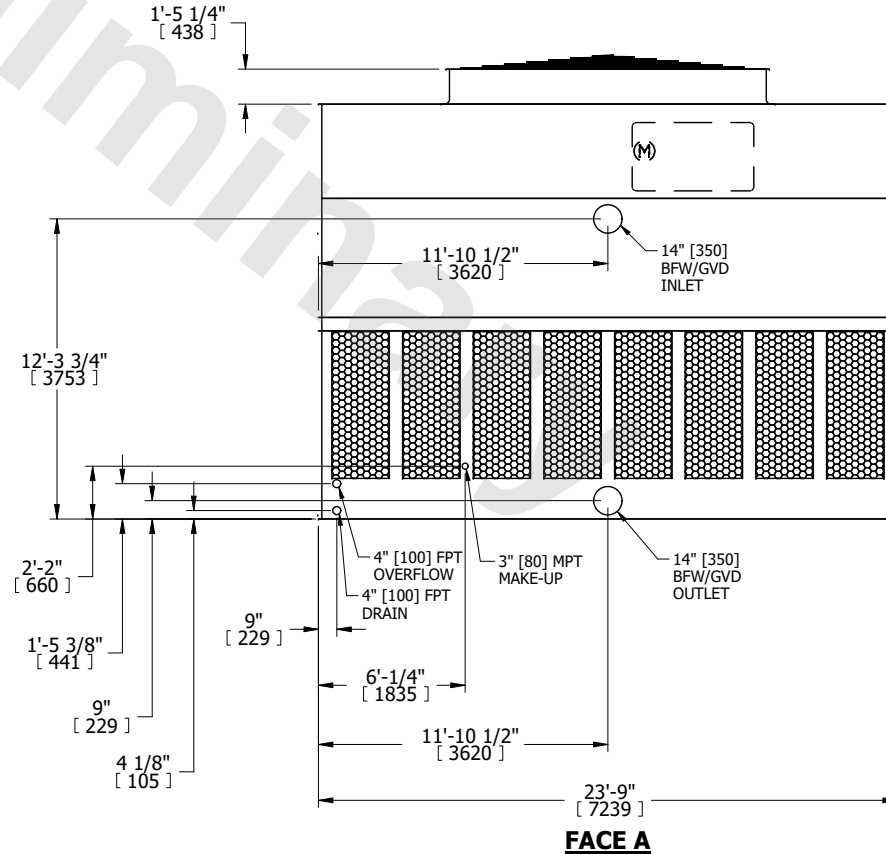
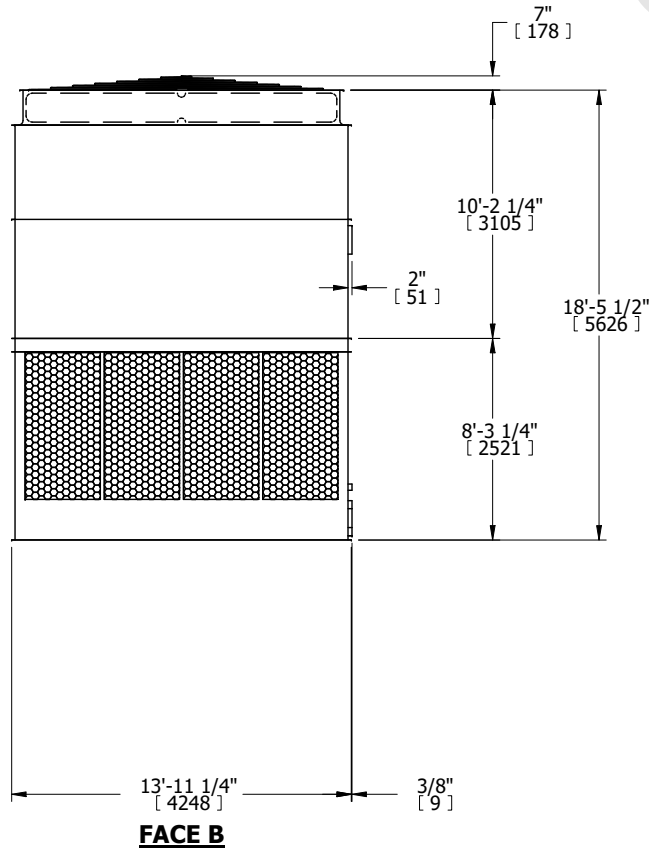

SHIPPING WEIGHT	18480 lbs+ [8385] kg+	OPERATING WEIGHT	34760 lbs+ [15770] kg+	HEAVIEST SECTION WEIGHT	12210 lbs+ [5540] kg+	NO. OF SHIPPING SECTIONS	2	DRAWN BY:	MER
-----------------	-----------------------	------------------	------------------------	-------------------------	-----------------------	--------------------------	---	-----------	-----