

UNIT	COOLING TOWER	
MODEL #	AT 210-4N24	SCALE NTS

# EVAPCO, INC.

DWG. #	T3TM2448-DRD-ST	REV.	-
SERIAL #		DATE	4/4/2026

- NOTES:
1. (M)- FAN MOTOR LOCATION
  2. HEAVIEST SECTION IS UPPER SECTION
  3. MPT DENOTES MALE PIPE THREAD  
FPT DENOTES FEMALE PIPE THREAD  
BFW DENOTES BEVELED FOR WELDING  
GVD DENOTES GROOVED  
FLG DENOTES FLANGE
  4. +UNIT WEIGHT DOES NOT INCLUDE ACCESSORIES (SEE ACCESSORY DRAWINGS)
  5. MAKE-UP WATER PRESSURE  
20 psi MIN [137 kPa], 50 psi MAX [344 kPa]
  6. 3/4" [19MM] DIA. MOUNTING HOLES. REFER TO RECOMENDED STEEL SUPPORT DRAWING.
  7. DIMENSIONS LISTED AS FOLLOWS:  
ENGLISH FT-IN  
[METRIC] [mm]

**FACE B**  
**PLAN VIEW**



**FACE A**

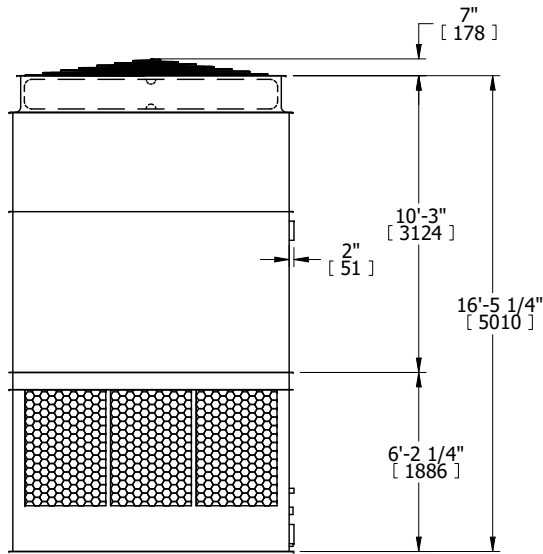

**FACE B**

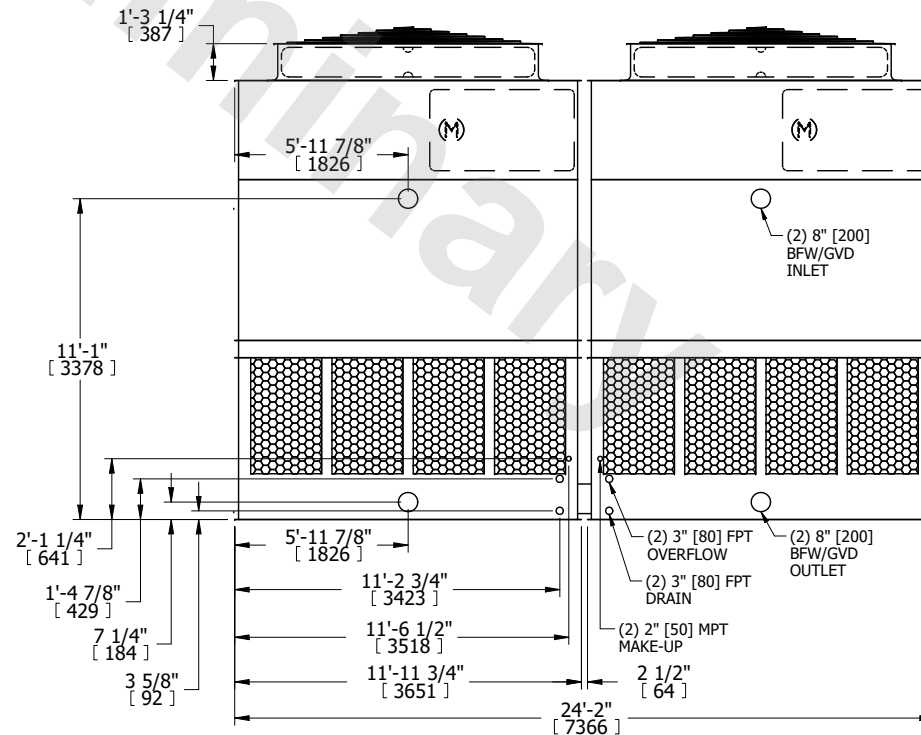

**FACE A**

SHIPPING WEIGHT	16120 lbs+ [7315] kg+	OPERATING WEIGHT	26040 lbs+ [11815] kg+	HEAVIEST SECTION WEIGHT	5620 lbs+ [2550] kg+	NO. OF SHIPPING SECTIONS	4	DRAWN BY:	JLG
-----------------	-----------------------	------------------	------------------------	-------------------------	----------------------	--------------------------	---	-----------	-----