

UNIT CLOSED CIRCUIT COOLER	SCALE NTS
MODEL # ESW4 14-25M22-AP	

# EVAPCO, INC.

DWG. # WX414222410-DRB-ST	REV -
SERIAL #	DATE: 7/11/2026

- NOTES:
- (M)- FAN MOTOR LOCATION
  - HEAVIEST SECTION IS COIL SECTION
  - MPT DENOTES MALE PIPE THREAD  
FPT DENOTES FEMALE PIPE THREAD  
BFW DENOTES BEVELED FOR WELDING  
GVD DENOTES GROOVED  
FLG DENOTES FLANGE
  - +UNIT WEIGHT DOES NOT INCLUDE ACCESSORIES (SEE ACCESSORY DRAWINGS)
  - 3/4" [19MM] DIA. MOUNTING HOLES. REFER TO RECOMMENDED STEEL SUPPORT DRAWING
  - MAKE-UP WATER PRESSURE  
20 psi MIN [137 kPa], 50 psi MAX [344 kPa]
  - DIMENSIONS LISTED AS FOLLOWS:  
ENGLISH FT-IN  
[METRIC] [mm]
  - \* - APPROXIMATE DIMENSIONS DO NOT USE FOR PRE-FABRICATION OF CONNECTING PIPING

**FACE B  
PLAN VIEW**

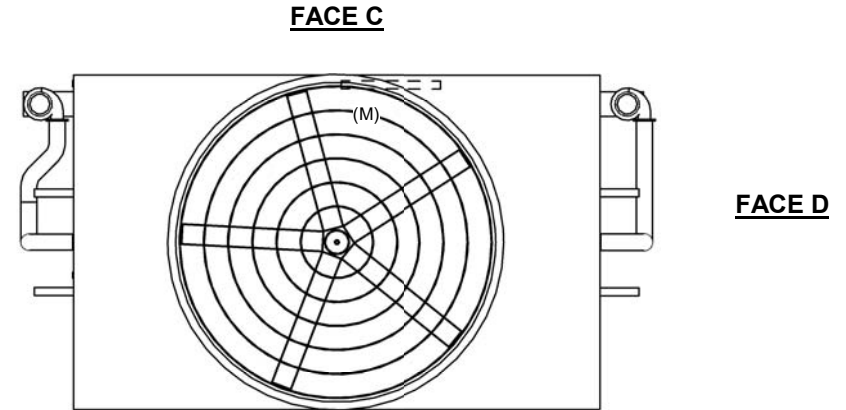

**FACE A**



**FACE A**



**FACE B**

MODEL NUMBER	DIMENSION A
ESW4 14-25*22-LP	2'-1 3/4"
ESW4 14-25*22-AP	2'-7 1/4"

SHIPPING WEIGHT 41560 lbs+ [18855] kg+	OPERATING WEIGHT 62180 lbs+ [28205] kg+	HEAVIEST SECTION WEIGHT 30410 lbs+ [13795] kg+	NO. OF SHIPPING SECTIONS 2	DRAWN BY: JLG
---	--	---	-------------------------------	------------------