

CONFIDENTIAL

This document is the property of Evapco, Inc. It should not be copied or disclosed without prior written authorization.

CUSTOMER	MODEL #	U-SSTWE1-9R66F0075F3KA	SCALE	N.T.S.	DWG. #	USSTW1-SE-6L	REV.	0	DATE	5/15/2026
----------	---------	------------------------	-------	--------	--------	--------------	------	---	------	-----------

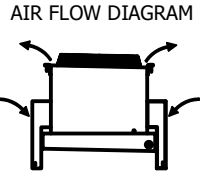

- NOTES:**
- 1) * = HANGER HOLE LOCATION.
 - 2) HANGER HOLES ARE FOR 3/4 INCH THREADED ROD.
 - 3) ALL DIMENSIONS ARE FOR REFERENCE AND SHOULD NOT BE USED FOR PREFABRICATION OF PIPING OR SUPPORTS.

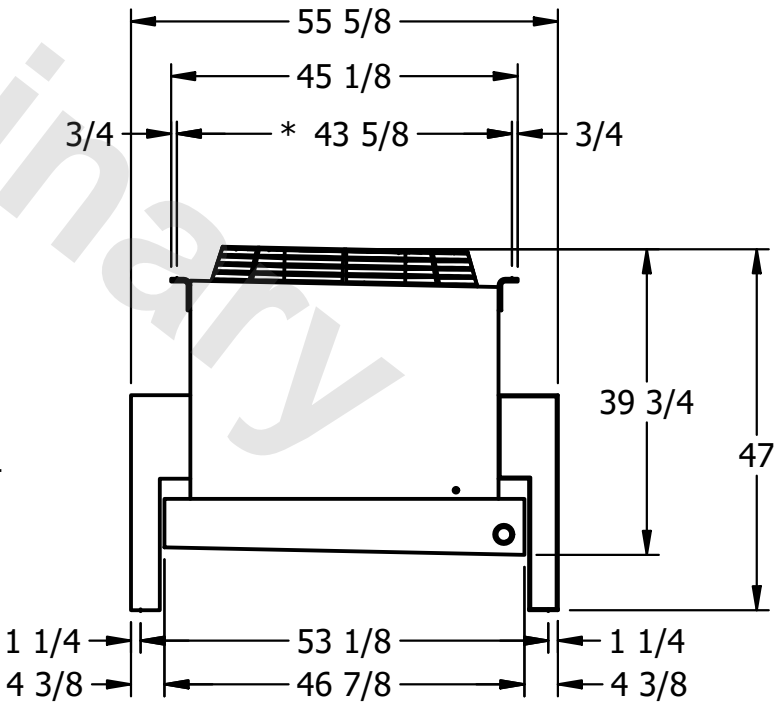
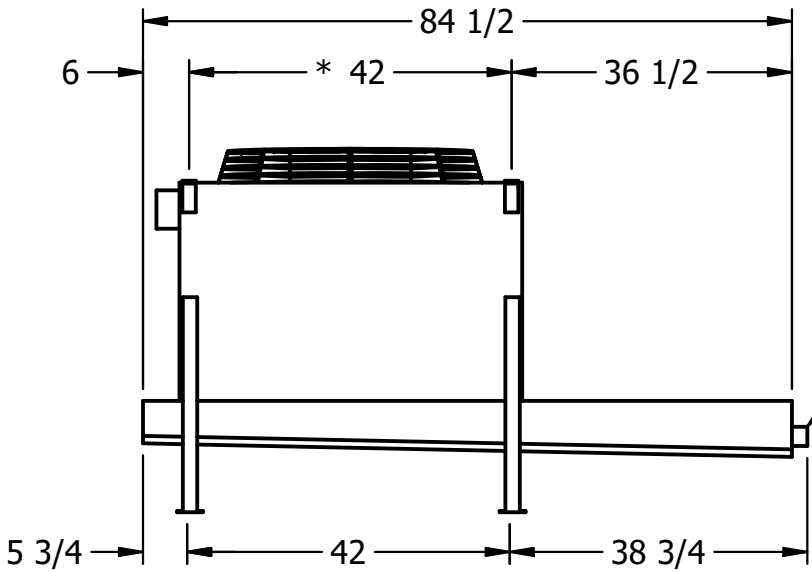

2" MPT DRAIN

PROJECT	ROOM	SHIPPING WEIGHT	610 lbs+ [280] kg+	OPERATING WEIGHT	700 lbs+ [320] kg+
---------	------	-----------------	--------------------	------------------	--------------------