

**CONFIDENTIAL**

This document is the property of Evapco, Inc. It should not be copied or disclosed without prior written authorization.

CUSTOMER	MODEL # U-SSTWE3-28R66F0100F1KA	SCALE N.T.S.	DWG. # USSTW3-SE-6L	REV. 0	DATE 5/17/2026
----------	---------------------------------	--------------	---------------------	--------	----------------



- NOTES:**
- 1) \* = HANGER HOLE LOCATION.
  - 2) HANGER HOLES ARE FOR 3/4 INCH THREADED ROD.
  - 3) ALL DIMENSIONS ARE FOR REFERENCE AND SHOULD NOT BE USED FOR PREFABRICATION OF PIPING OR SUPPORTS.

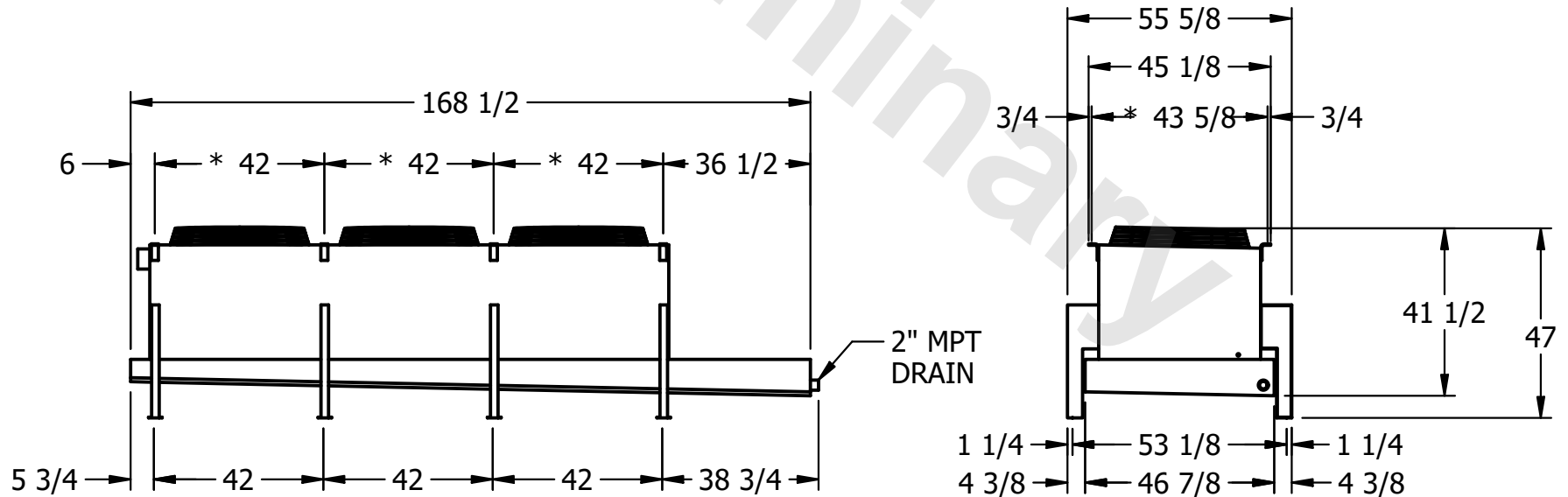

PROJECT	ROOM	SHIPPING WEIGHT 1540 lbs+ [700] kg+	OPERATING WEIGHT 1800 lbs+ [820] kg+
---------	------	-------------------------------------	--------------------------------------