

CONFIDENTIAL

This document is the property of Evapco, Inc. It should not be copied or disclosed without prior written authorization.

| | | | | | |
|----------|--------------------------------|--------------|---------------------|--------|----------------|
| CUSTOMER | MODEL # U-SSTWE1-9R64H0150F1LA | SCALE N.T.S. | DWG. # USSTW1-SE-6L | REV. 0 | DATE 5/15/2026 |
|----------|--------------------------------|--------------|---------------------|--------|----------------|

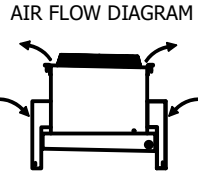

- NOTES:**
- 1) * = HANGER HOLE LOCATION.
 - 2) HANGER HOLES ARE FOR 3/4 INCH THREADED ROD.
 - 3) ALL DIMENSIONS ARE FOR REFERENCE AND SHOULD NOT BE USED FOR PREFABRICATION OF PIPING OR SUPPORTS.

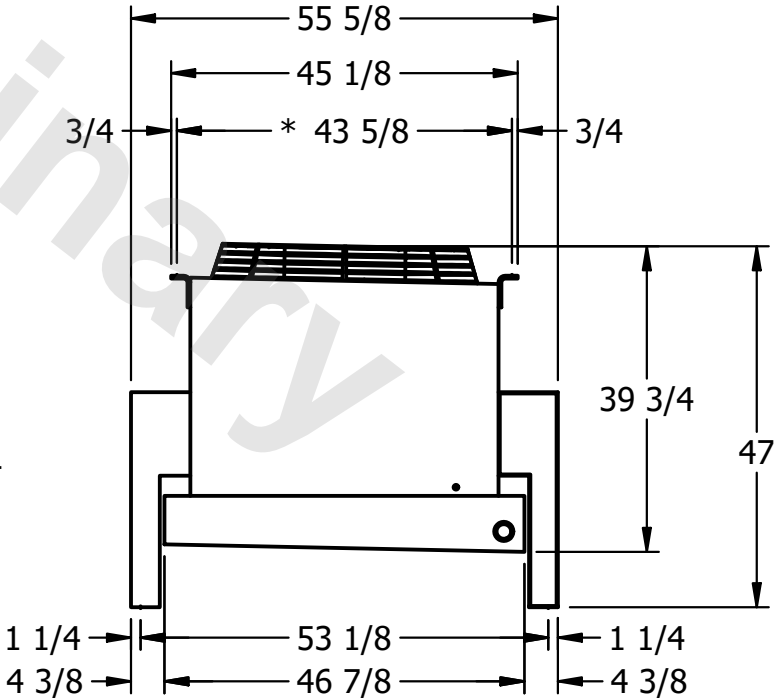
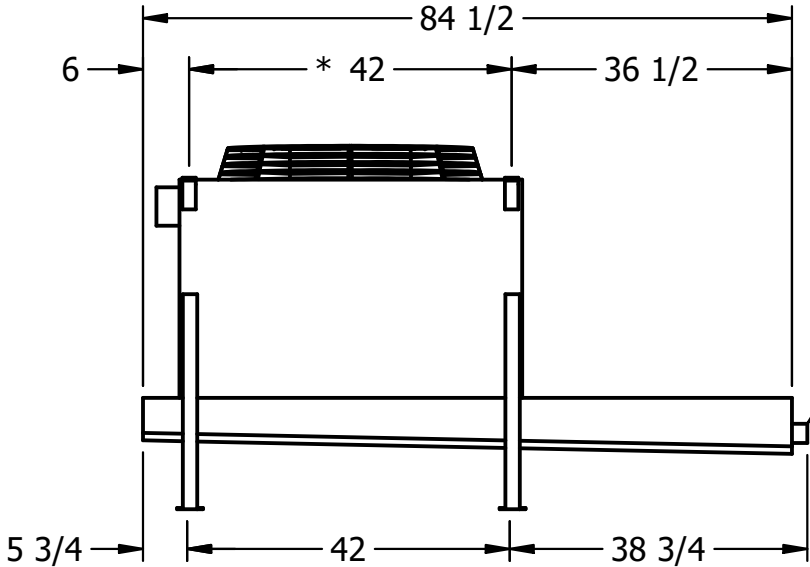

2" MPT DRAIN

| | | | |
|---------|------|------------------------------------|-------------------------------------|
| PROJECT | ROOM | SHIPPING WEIGHT 660 lbs+ [300] kg+ | OPERATING WEIGHT 730 lbs+ [335] kg+ |
|---------|------|------------------------------------|-------------------------------------|