

CONFIDENTIAL

This document is the property of Evapco, Inc. It should not be copied or disclosed without prior written authorization.

CUSTOMER	MODEL # U-SSTWE1-9S63H0075F3LA	SCALE N.T.S.	DWG. # USSTW1-SE-8	REV. 0	DATE 5/15/2026
----------	--------------------------------	--------------	--------------------	--------	----------------



- NOTES:**
- 1) * = HANGER HOLE LOCATION.
 - 2) HANGER HOLES ARE FOR 3/4 INCH THREADED ROD.
 - 3) ALL DIMENSIONS ARE FOR REFERENCE AND SHOULD NOT BE USED FOR PREFABRICATION OF PIPING OR SUPPORTS.

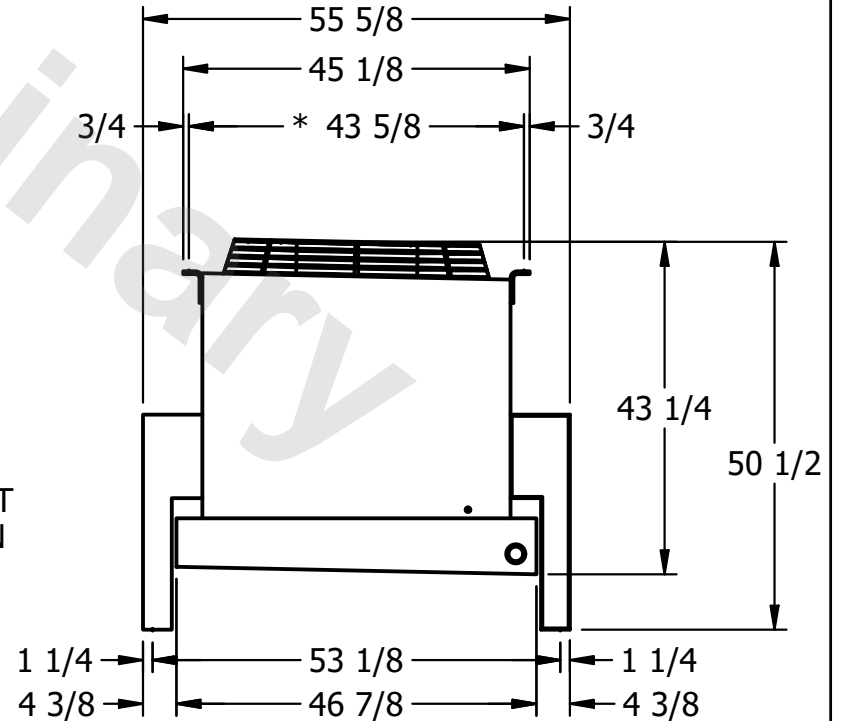
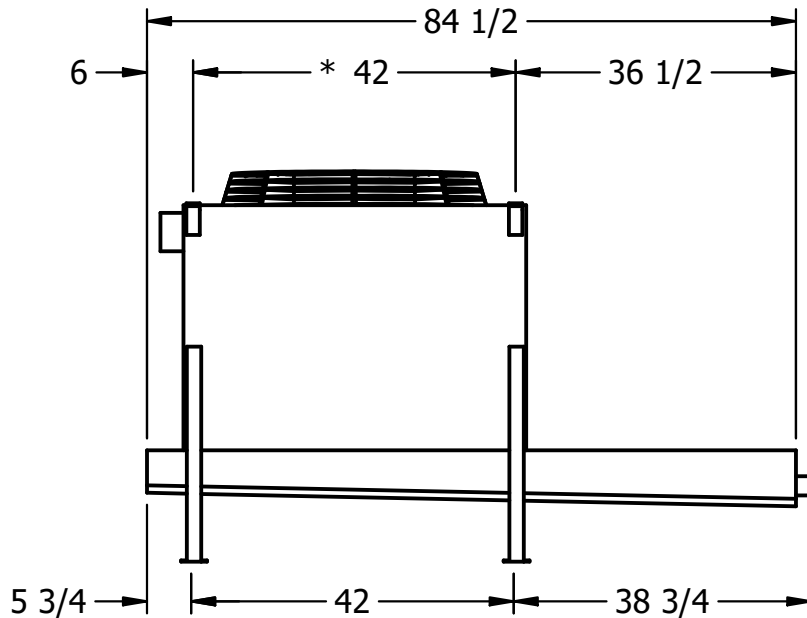

PROJECT	ROOM	SHIPPING WEIGHT 580 lbs+ [265] kg+	OPERATING WEIGHT 630 lbs+ [290] kg+
---------	------	------------------------------------	-------------------------------------