

**CONFIDENTIAL**

This document is the property of Evapco, Inc. It should not be copied or disclosed without prior written authorization.

CUSTOMER	MODEL # U-SSTWE2-19R64H0075F1LA	SCALE N.T.S.	DWG. # USSTW2-SE-6L	REV. 0	DATE 5/16/2026
----------	---------------------------------	--------------	---------------------	--------	----------------

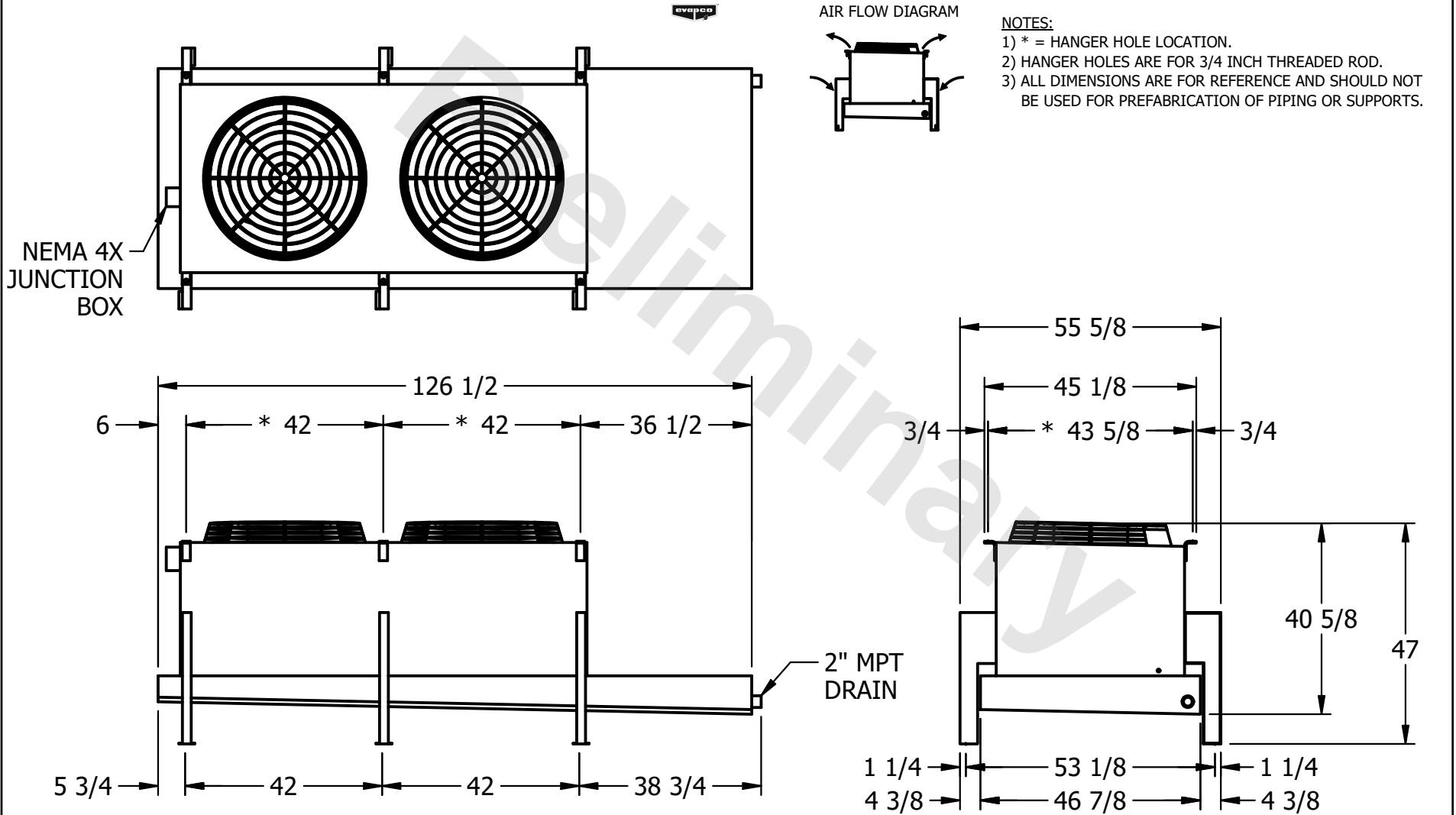

PROJECT	ROOM	SHIPPING WEIGHT 1150 lbs+ [525] kg+	OPERATING WEIGHT 1280 lbs+ [585] kg+
---------	------	-------------------------------------	--------------------------------------