

**CONFIDENTIAL**

This document is the property of Evapco, Inc. It should not be copied or disclosed without prior written authorization.

CUSTOMER	MODEL # U-SSTWE3-28R46H0075F3LA	SCALE N.T.S.	DWG. # USSTW3-SE-4L	REV. 0	DATE 5/17/2026
----------	---------------------------------	--------------	---------------------	--------	----------------

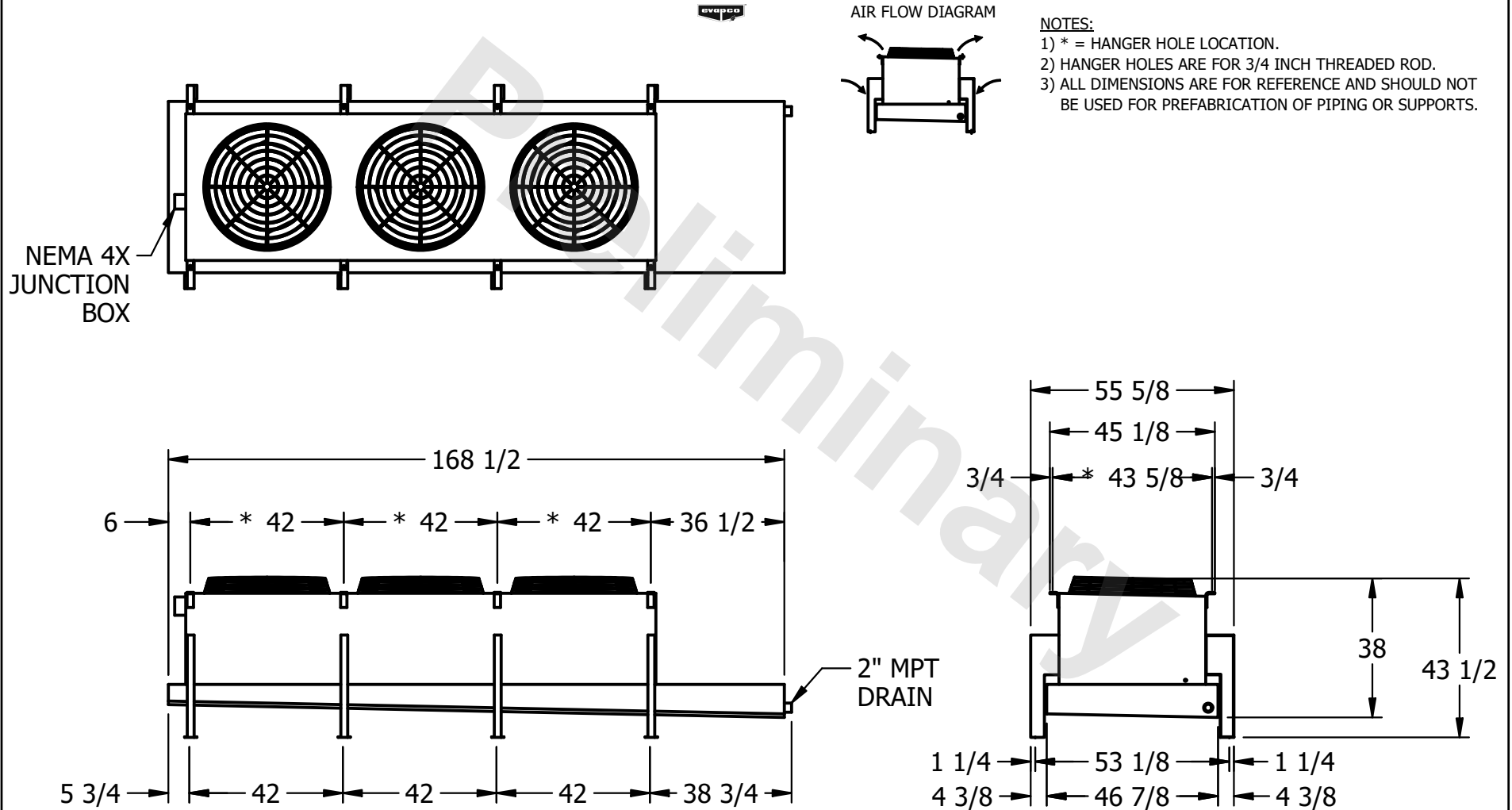

PROJECT	ROOM	SHIPPING WEIGHT 1530 lbs+ [695] kg+	OPERATING WEIGHT 1700 lbs+ [775] kg+
---------	------	-------------------------------------	--------------------------------------